

REVISIONS					
REV	ECO	DESCRIPTION	DATE	BY	APPR
A3		RELEASE NEW DWG FORMAT	06/07/13	DRP	

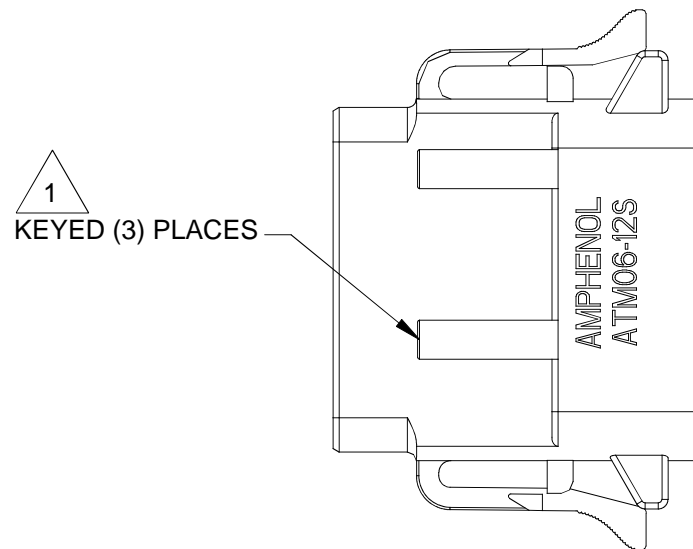

REQUIRES CONTACT RETENTION WEDGE AWM-12S

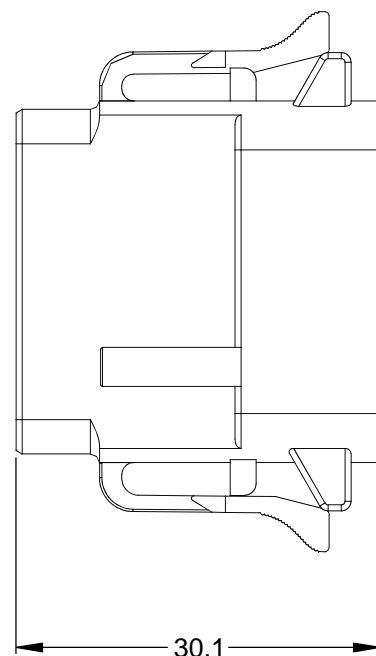
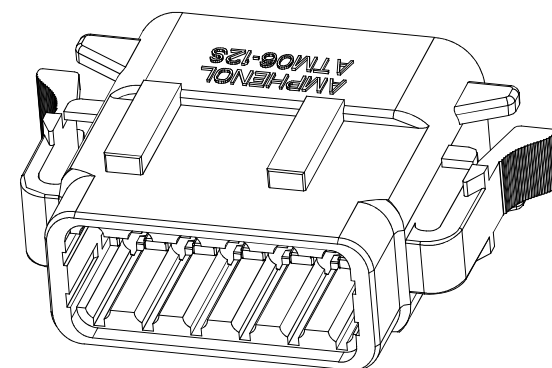
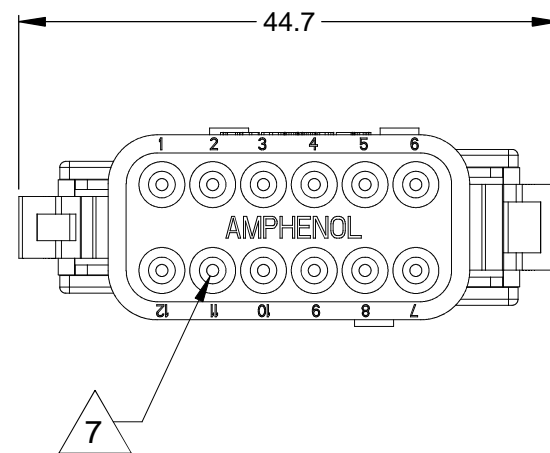
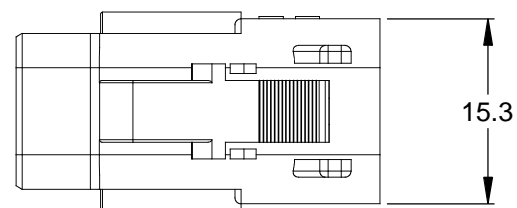
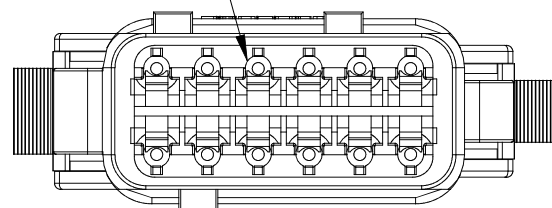

NOTES: UNLESS OTHERWISE SPECIFIED

1 SEE SHEET 2 FOR KEY ARRANGEMENTS AND COLORS.

2. MATERIAL:
HOUSING: THERMOPLASTIC
SEAL: SILICONE RUBBER

3. MODIFICATIONS: N/A

4. SPECIFICATIONS:
4.1 CURRENT RATING: 7.5 AMPS
4.2 OPERATING TEMPERATURE: -55°C TO +125°C
4.3 DIELECTRIC WITHSTANDING VOLTAGE: LESS THAN 2 MILLIAMPS CURRENT LEAKAGE @ 1500 VOLTS AC.
4.4 INSULATION RESISTANCE: 1000 MEGOHMS MIN @ 25°C.
4.5 MOISTURE RESISTANCE: IP67 (MATED CONDITION)
4.6 MATING CYCLE DURABILITY: 100 CYCLES
4.7 RoHS COMPLIANT

5. MATING PART: ATM04-12PX* RECEPTACLE.
(X = A,B,C,D KEYS; * = MODIFICATIONS AND COLORS)

6. ALL DIMENSIONS ARE FOR REFERENCE USE ONLY.

7 CONTACT SIZE AND REAR SEAL WIRE RANGE:

CONTACT SIZE	MIN. INSUL O.D.	MAX. INSUL O.D.	TYPICAL WIRE RANGE
20	1.35 mm (.053 in)	3.05 mm (.120 in)	16 - 22 AWG

TITLE: PLUG, KEYED, 12 SOCKET, ATM SERIES

DWG NO.: ATM06-12SX-XXX

REV: A3

SH: 1

OF: 2

SEE SHEET 2		DESCRIPTION		ITEM
QUANTITY	PART NUMBER	MATERIALS LIST		
UNLESS OTHERWISE SPECIFIED		SIGNATURES		DATE
1) All dimensions are in metric (mm). 2) Tolerances are as follows: 1 PL DEC ±0.30 2 PL DEC ±0.15 3 PL DEC ±0.08		DRAWN: D.PARKS		18/JUN/13
Fractions ±1/64 Angles ±1°		CHECKED:		
3) Note reference = X		ENGINEER:		
MATERIAL SPECIFICATIONS:		APPROVAL:		
PROCESS SPECIFICATIONS:		CUSTOMER:		
NEXT ASSY:		THIS DRAWING IS SUPPLIED FOR INFORMATION ONLY. DESIGN FEATURES, SPECIFICATIONS AND PERFORMANCE DATA SHOWN HEREON ARE THE PROPERTY OF THE AMPHENOL CORPORATION. NO RIGHTS OF REPRODUCTION ARE IMPLIED. ALL DIMENSIONS ARE SUBJECT TO NORMAL MANUFACTURING VARIATIONS.		
		<p style="text-align: center;">Amphenol</p> <p style="text-align: center;">Sine Systems - www.amphenol-sine.com 44724 Morley Drive Clinton Township, MI 48036</p>		
		<p style="text-align: center;">PLUG, KEYED, 12 SOCKET, ATM SERIES</p>		
SIZE	TYPE	DWG NO.	REVISION	
B	C-	ATM06-12SX-XXX	A3	
SCALE:	NONE	SHEET 1 OF 2		

REVISIONS					
REV	ECO	DESCRIPTION	DATE	BY	APPR

P/N ATM06-12SA
KEY-A CONFIGURATION
STANDARD COLOR: GREY

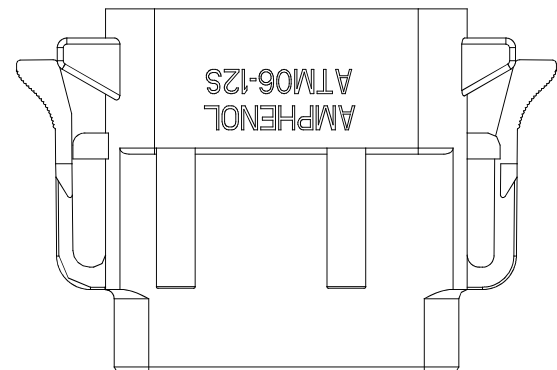

P/N ATM06-12SB
KEY-B CONFIGURATION
STANDARD COLOR: BLACK

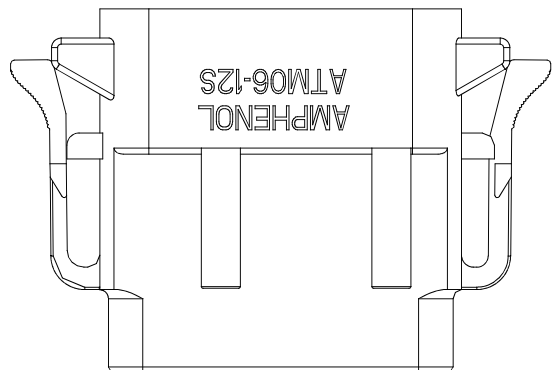

P/N ATM06-12SC
KEY-C CONFIGURATION
STANDARD COLOR: GREEN

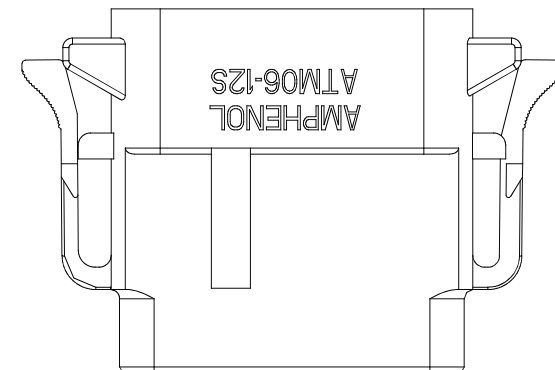

P/N ATM06-12SD
KEY-D CONFIGURATION
STANDARD COLOR: BROWN

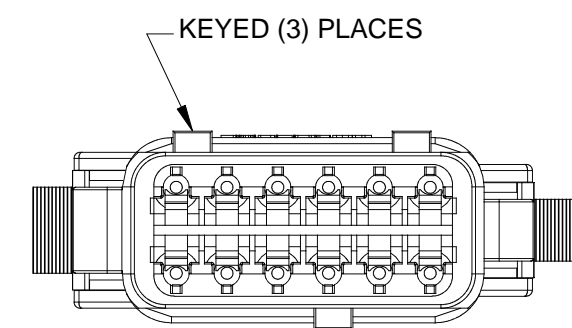
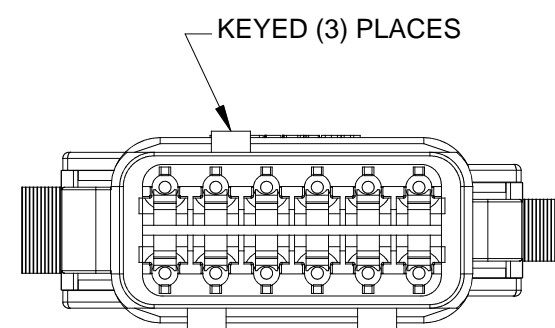
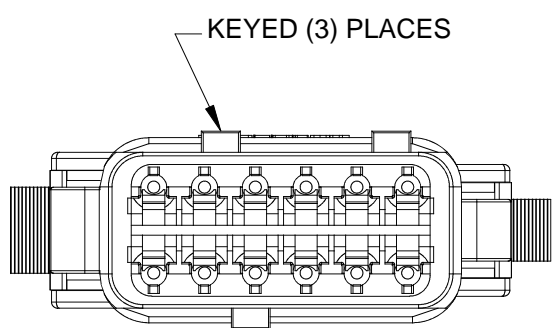
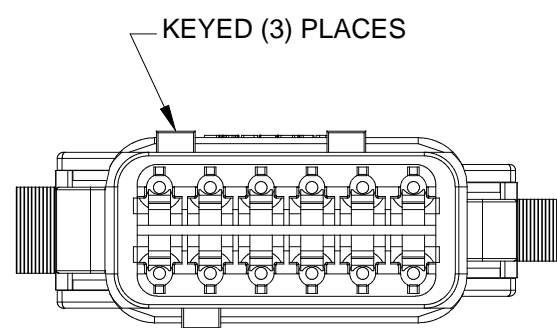
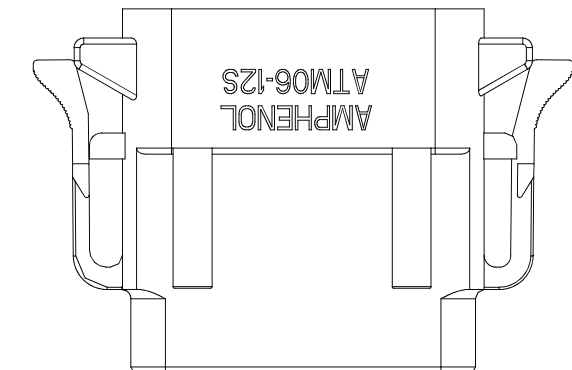

KEY-A CONFIGURATION	
COLOR	PART NUMBER
* GREY	ATM06-12SA
BLACK	ATM06-12SA-BLK
GREEN	ATM06-12SA-GRN
BROWN	ATM06-12SA-BRN

KEY-B CONFIGURATION	
COLOR	PART NUMBER
GREY	ATM06-12SB-GRY
* BLACK	ATM06-12SB
GREEN	ATM06-12SB-GRN
BROWN	ATM06-12SB-BRN

KEY-C CONFIGURATION	
COLOR	PART NUMBER
GREY	ATM06-12SC-GRY
BLACK	ATM06-12SC-BLK
* GREEN	ATM06-12SC
BROWN	ATM06-12SC-BRN

KEY-D CONFIGURATION	
COLOR	PART NUMBER
GREY	ATM06-12SD-GRY
BLACK	ATM06-12SD-BLK
GREEN	ATM06-12SD-GRN
* BROWN	ATM06-12SD

NOTE:

AN ASTERISKS (*) PLACED BEFORE THE COLOR DENOTES THE STANDARD MOLDED COLOR OF THE CONNECTORS SHOWN ABOVE.

OTHER COLORS SHOWN ARE AVAILABLE VIA SPECIAL ORDER.

TITLE: PLUG, KEYED, 12 SOCKET, ATM SERIES
DWG NO: ATM06-12SX-XXX
REV: A3
SH: 2
OF: 2

QUANTITY	PART NUMBER	DESCRIPTION	ITEM
MATERIALS LIST			
UNLESS OTHERWISE SPECIFIED 1) All dimensions are in metric (mm). 2) Tolerances are as follows: 1 PL DEC ±0.30 2 PL DEC ±0.15 3 PL DEC ±0.08 Fractions ±1/64 Angles ±1° 3) Note reference =		SIGNATURES DATE DRAWN: D.PARKS 18/JUN/13 CHECKED: ENGINEER: APPROVAL:	
MATERIAL SPECIFICATIONS:		CUSTOMER:	
PROCESS SPECIFICATIONS:		THIS DRAWING IS SUPPLIED FOR INFORMATION ONLY. DESIGN FEATURES, SPECIFICATIONS AND PERFORMANCE DATA SHOWN HEREON ARE THE PROPERTY OF THE AMPHENOL CORPORATION. NO RIGHTS OF REPRODUCTION ARE IMPLIED. ALL DIMENSIONS ARE SUBJECT TO NORMAL MANUFACTURING VARIATIONS.	
NEXT ASSY:		SCALE: NONE	
		 Sine Systems - www.amphenol-sine.com 44724 Morley Drive Clinton Township, MI 48036 PLUG, KEYED, 12 SOCKET, ATM SERIES	
		SIZE: B C-	REVISION: A3
		DWG NO: ATM06-12SX-XXX	SHEET 2 OF 2

Mouser Electronics

Authorized Distributor

Click to View Pricing, Inventory, Delivery & Lifecycle Information:

[Amphenol:](#)

[ATM06-12SA](#)