



Typical unit

FEATURES

- 4.5 - 17Vdc Input Voltage range
(Absolute maximum input voltage:18Vdc)
- Programmable output voltage range from 1 to 5.25Vdc
- Up to 2.5A of output current
- Ultra small surface mount package
- 7.9 x 7.9 x 2.3mm
- High efficiency : 88%
- Short Circuit Protection
- On/Off control (Positive logic)
- Operating Temperature range -40 to +85 degC

PRODUCT OVERVIEW

MYLSM00502EPRL is Surface Mount type of DC-DC power converter for embedded applications. The tiny form factor measures only 7.9 x 7.9 x 2.3 mm. The wide input range is 4.5 to 17Vdc. The maximum output current of 2.5A. Based on Hi-frequency synchronous buck converter switching topology, the high power conversion efficient module features programmable output voltage and On/Off control. This converter also include output short circuit protection.

SIMPLIFIDE APPLICATION

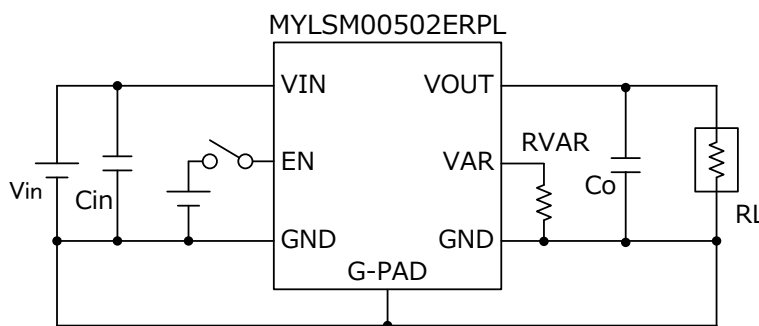

Cin : 10 μ F/25V × 1pcs
Co : 47 μ F/6.3V × 1pcs



PERFORMANCE SPECIFICATIONS SUMMARY AND ORDERING GUIDE

Model Number	Output						Input				Efficiency (%)	Package (mm)
	Vo (Vdc)	Io (A,Max.)	Power (W)	R/N Max. (mV p-p)	Regulation		Vin typ. (Vdc)	Range (Vdc)	lin, no load Typ.(mA)	lin, full load Typ.(A)		
					Line (%)	Load (%)						
MYLSM00502ERPL	1 - 5.25	2.5	13.1	30	±2.0	±2.0	12	4.5 - 17	10	1.25	88	7.9 x 7.9 x 2.3

- 1.Specification of R/N MAX. is at typical Input voltage, Vo = 1.0V and Io = 2.5A, +25degC. Output capacitor is 47uF ceramic capacitor. Input capacitors is 10uF ceramic capacitors. See detailed specifications. Input and output capacitors are necessary for our test equipment.
2. Specification of Regulation and Efficiency are at Io = 2.5A.
- 3.Use adequate ground plane and copper thickness adjacent to the converter.

PART NUMBER STRUCTURE

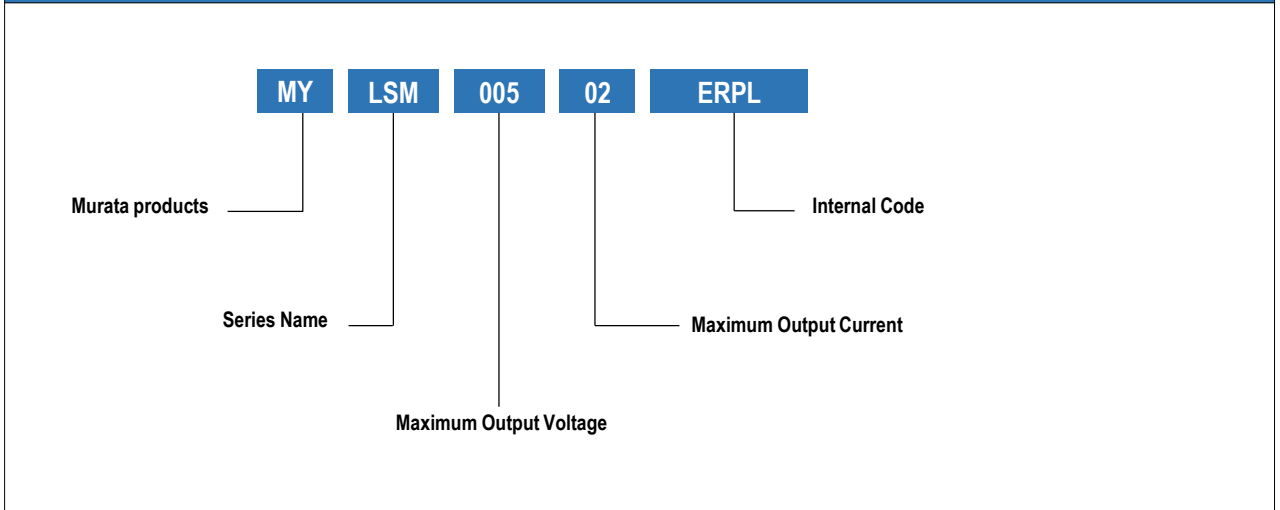

PRODUCT MARKING

Because of the small size of these products, the product marking contains a character-reduced code to indicate the model number and manufacturing date code. Not all items on the marking are always used. Please note that the marking differs from the product photograph. Here is the layout of the Marking.

Layout

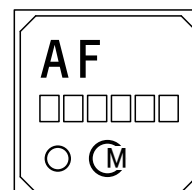

1pin

Codes

Item	Contents
AF	Product Code
□□□□□□	Lot No. (6-digit alphanumeric)
Ⓜ	Manufacturer ID

FUNCTIONAL SPECIFICATIONS

ABSOLUTE MAXIMUM RATINGS	Conditions	Minimum	Typical / Nominal	Maximum	Units
Input Voltage, Continuous		-0.3		18	Vdc
EN		-0.3		Vin	Vdc
VAR pin			Source ONLY		
Storage Temperature Range	Vin = Zero (no power)	-40		85	degC
Absolute maximums are stress ratings. Exposure of devices to greater than any of these conditions may adversely affect long-term reliability. Proper operation under conditions other than those listed in the Performance/Functional Specifications Table is not implied or recommended.					
INPUT	Conditions	Minimum	Typical / Nominal	Maximum	Units
Operating Voltage Range (Vin)	Vin>Vo +3.0	4.5	12	17	Vdc
Startup threshold	Rising input voltage Vo = 1V		3.6		Vdc
Shutdown threshold	Shutdown input voltage Vo = 1V		2.9		Vdc
Input current					
Full Load Conditions	Vin = 12V, Vo = 5.25V, Io = 2.5A		1.25		A
No Load Current	Vin = 12V, Vo = 5.25V, Io = 0A		10		mA
EN pin Voltage	Power ON	1		Vin	Vdc
	Power OFF			0.3	Vdc
GENERAL	Conditions	Minimum	Typical / Nominal	Maximum	Units
Efficiency	Vin = 12V, Vo = 5.25V, Io = 2.5A		88		%
DYNAMIC CHARACTERISTICS	Conditions	Minimum	Typical / Nominal	Maximum	Units
Fixed Switching Frequency	Vo = 3.3V, Io = 2.5A		2500		kHz
Startup Time (Vin ON)			1.6		ms
Startup Time (EN ON)			1.6		ms
OUTPUT	Conditions	Minimum	Typical / Nominal	Maximum	Units
Voltage					
Output Voltage Range (Vo)	RVER = 0Ω	5.09	5.25	5.41	Vdc
	RVER = 1.047kΩ	4.85	5.0	5.15	Vdc
	RVER = 14kΩ	3.2	3.3	3.4	Vdc
	RVER = 96.3kkΩ	1.45	1.5	1.55	Vdc
	RVER = 382kΩ	0.97	1.0	1.03	Vdc
Current					
Output Current Range (Io)		0		2.5	A
Short circuit protection method	Hiccup current limiting		Non-latching		
Ripple Voltage	Vin = 12V, Vo = 1V, Io = 2.5A 20 MHz BW		15	30	mV p-p
External Output Capacitive	Vo ≤ 2.5V	47		120	uF
	Vo > 2.5V	20		60	uF
MECHANICAL	Conditions	Minimum	Typical / Nominal	Maximum	Units
Outline Dimensions			7.9(typ.) x 7.9(typ.) x 2.3(max.)		mm
Weight			265		mgrams
ENVIRONMENTAL	Conditions	Minimum	Typical / Nominal	Maximum	Units
Operating Ambient Temperature Range		-40		85	degC
Storage Temperature		-40		85	degC
Moisture Sensitivity Level			2		

SPECIFICATIONS NOTES

(1) All models are tested and specified with external 47uF ceramic output capacitors and 10uF ceramic input capacitors. All capacitors are low ESR types. These capacitors are necessary to accommodate our test equipment and may not be required to achieve specified performance in your applications. However, Murata recommends installation of these capacitors.

(2) Note that Maximum Power Derating curves indicate an average current at typical input voltage. At higher temperatures and/or no airflow, the converter will tolerate brief full current outputs if the total RMS current over time does not exceed the Derating curve.

(3) The On/Off Control Input should use either a switch or an open collector/open drain transistor referenced to GND. A logic gate may also be used by applying appropriate external voltages which do not exceed +Vin

(4) "Hiccup" operation repeatedly attempts to restart the converter with a brief, full-current output. If the short circuit condition still exists, the restart current will be removed and then tried again. This short current pulse prevents overheating and damaging the converter. Once the fault is removed, the converter immediately recovers normal operation.

(5) Do not exceed maximum power specifications when adjusting the output trim.

(6) The maximum output capacitive loads depend on the Equivalent Series Resistance (ESR) of the external output capacitor and, to a lesser extent, the distance and series impedance to the load. Larger caps will reduce output noise but may change the transient response. Newer ceramic caps with very low ESR may require lower capacitor values to avoid instability. Thoroughly test your capacitors in the application. Please refer to the Output Capacitive Load Application Note.

(7) Do not allow the input voltage to degrade lower than the specified minimum voltage, at all times. Otherwise, you risk having the converter turn off. The under voltage shutdown is not latching and will attempt to recover when the input is brought back into normal operating range.

(8) Depending on the output condition during startup, overcurrent protection may operate.

(9) When the load current decreases, the converter enters Power Save Mode. And this mode the switching frequency decreases.

PERFORMANCE DATA AND OSCILLOGRAMS OF MYLSM00502EPRL

Efficiency vs. Line Voltage and Load Current @ +25degC. (Vo = 1.0V)

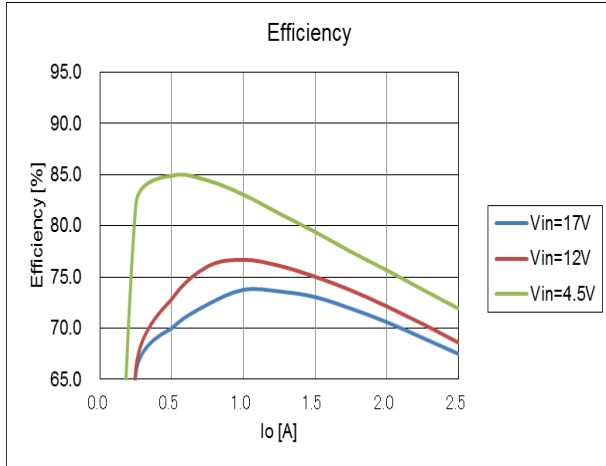

Vo vs. Line Voltage and Load Current @ +25degC. (Vo = 1.0V)

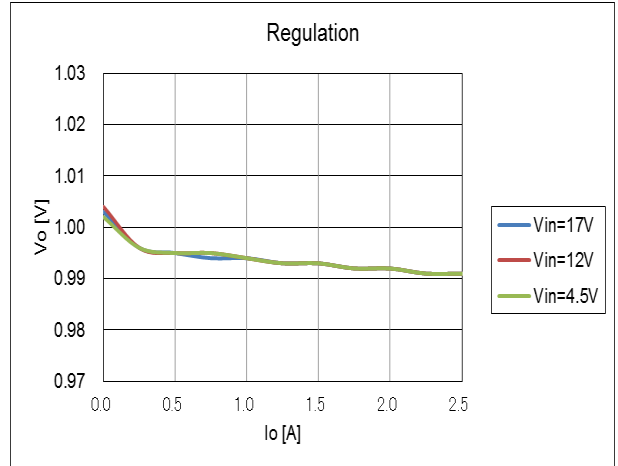

On/Off Enable Delay (Vin=12V, Vo=1.0V, Io=2.5A, Co = 47uF)
Trace1=Enable, Trace2=Vo, 400us/div

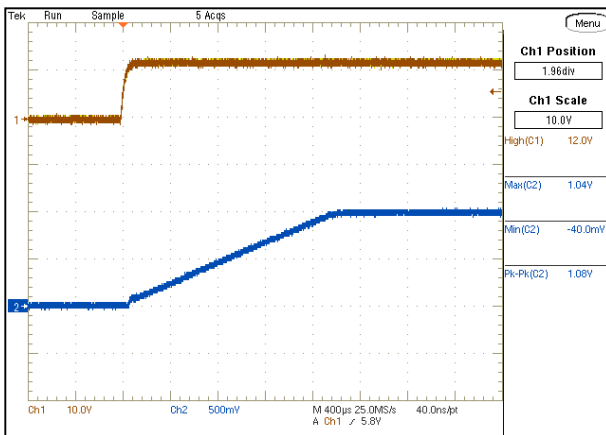

Output Ripple and Noise (Vin=12V, Vo=1.0V, Io=2.5A, Co = 47uF, Scope BW=20MHz)

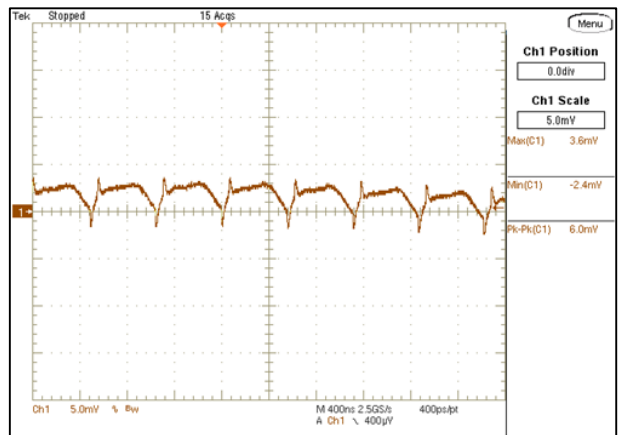

Step Load Transient Response (Vin=12V, Vo=1.0V, Co = 47uF,
Io=1.25A to 2.5A, 2.5A/us) Trace 3=Vo, 20mV/div, Trace 4=Io, 2A/div.

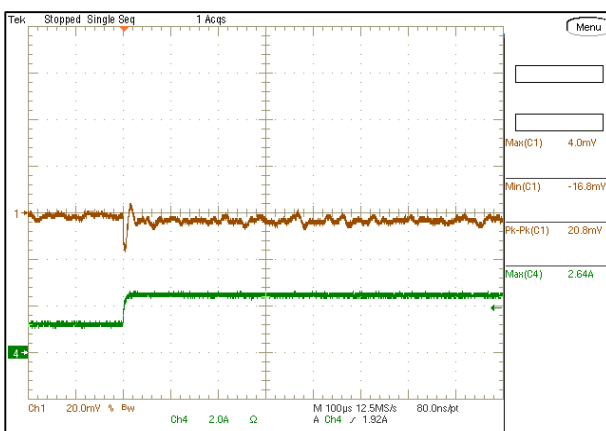

Step Load Transient Response (Vin=12V, Vo=1.0V, Co = 47uF, Io=1.25A to 2.5A, 2.5A/us)
Trace 3=Vo, 20mV/div, Trace 4=Io, 2A/div.

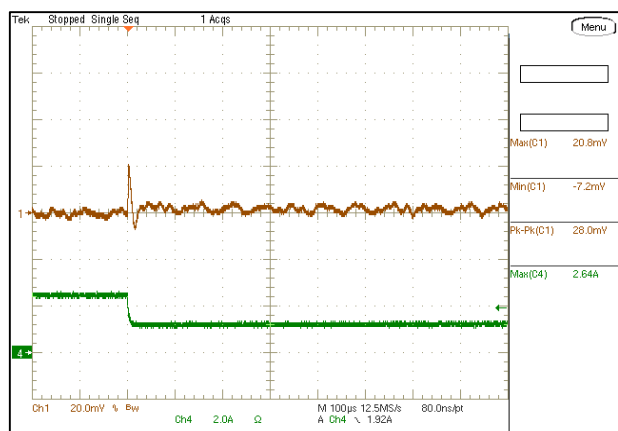

PERFORMANCE DATA AND OSCILLOGRAMS OF MYLSM00502ERPL

Efficiency vs. Line Voltage and Load Current @ +25degC. (Vo = 3.3V)

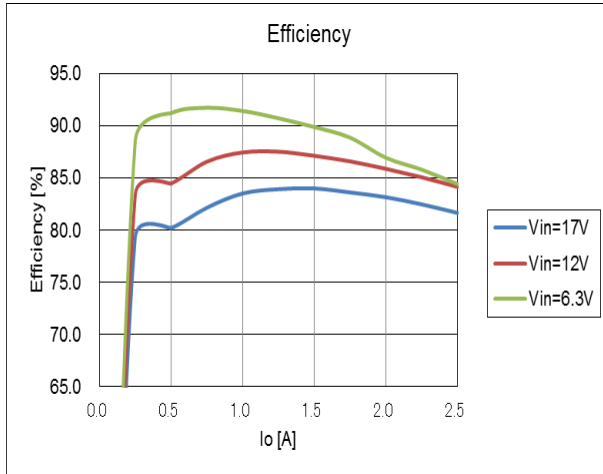

Vo vs. Line Voltage and Load Current @ +25degC. (Vo = 3.3V)

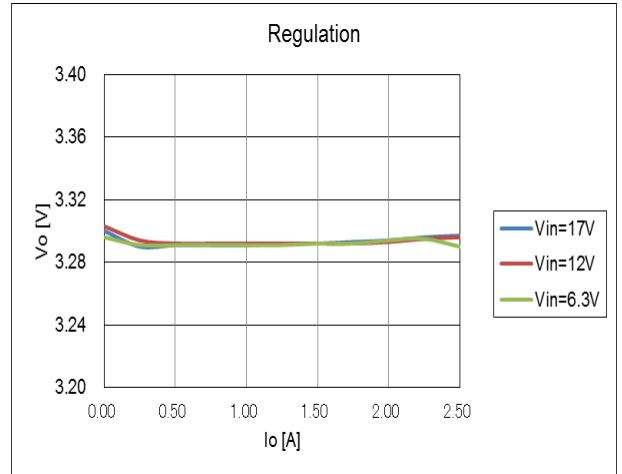

On/Off Enable Delay (Vin=12V, Vo=3.3V, Io=2.5A, Co = 47uF)
Trace1=Enable, Trace2=Vo, 400us/div

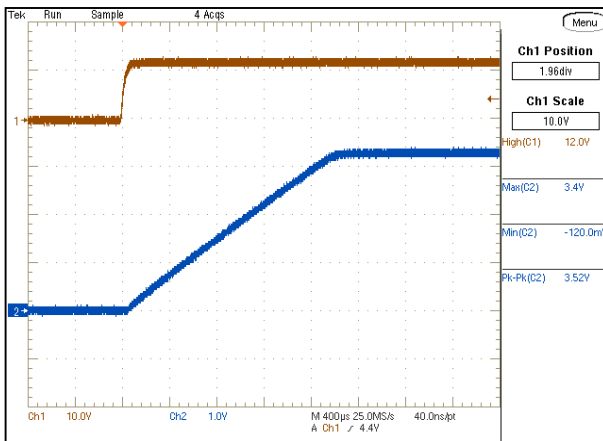

Output Ripple and Noise (Vin=12V, Vo=3.3V, Io=2.5A, Co = 47uF, Scope BW=20MHz)

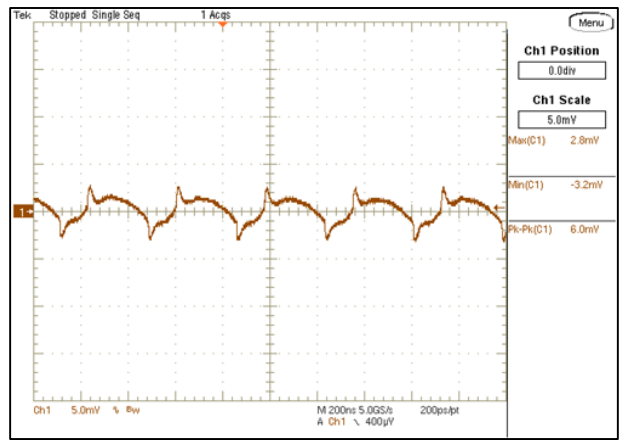

Step Load Transient Response (Vin=12V, Vo=3.3V, Co = 47uF,
Io=1.25A to 2.5A, 2.5A/us) Trace 3=Vo, 20mV/div, Trace 4=Io, 2A/div.

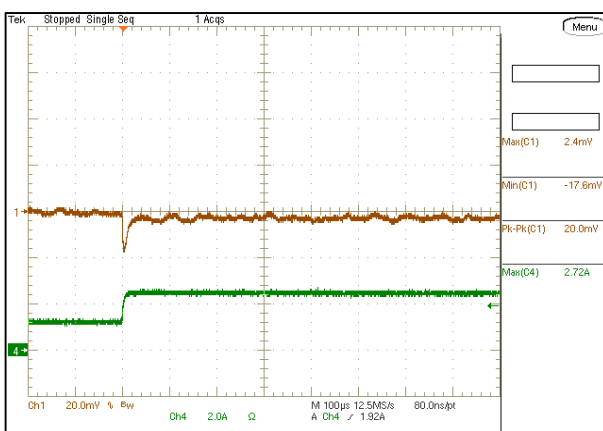

Step Load Transient Response (Vin=12V, Vo=3.3V, Co = 47uF, Io=1.25A to 2.5A, 2.5A/us)
Trace 3=Vo, 20mV/div, Trace 4=Io, 2A/div.

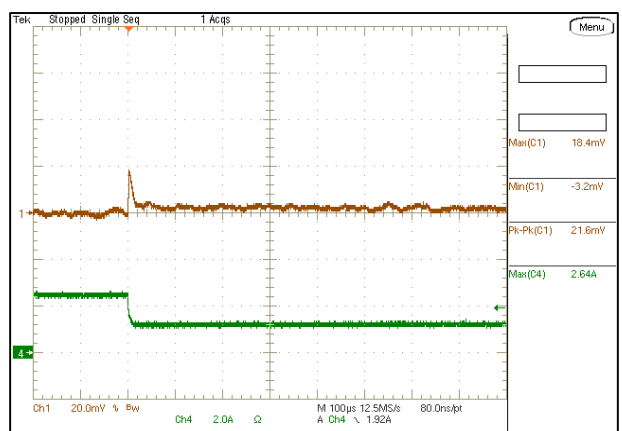

PERFORMANCE DATA AND OSCILLOGRAMS OF MYLSM00502EPRL

Efficiency vs. Line Voltage and Load Current @ +25degC. (Vo = 5.25V)

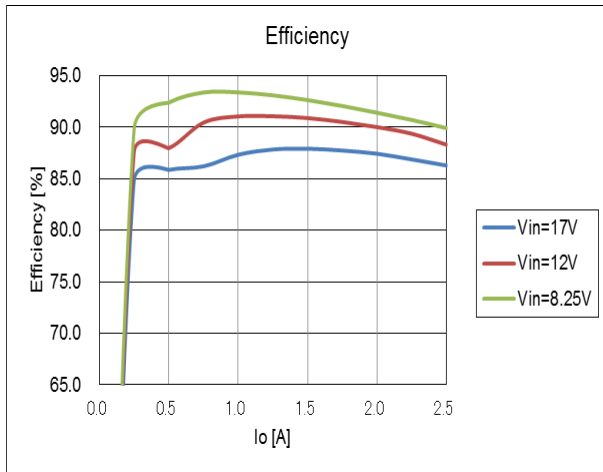

Vo vs. Line Voltage and Load Current @ +25degC. (Vo = 5.25V)

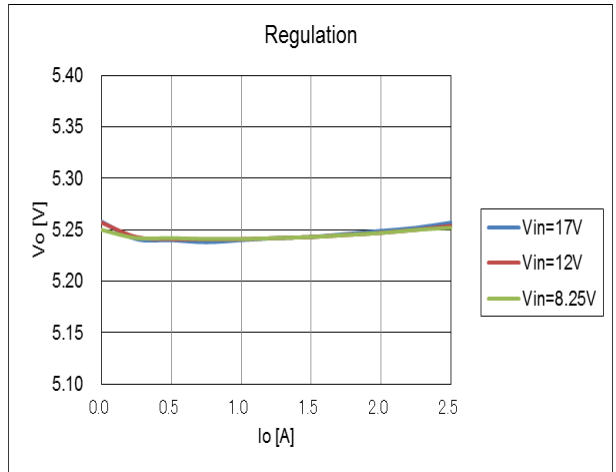

On/Off Enable Delay (Vin=12V, Vo=5.25V, Io=2.5A, Co = 47uF)
Trace1=Enable, Trace2=Vo, 400us/div

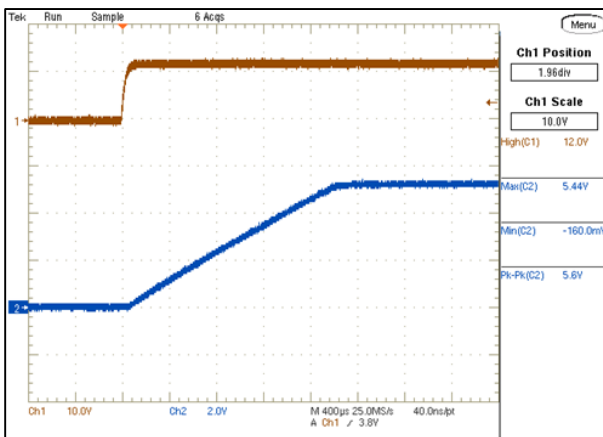

Output Ripple and Noise (Vin=12V, Vo=5.25V, Io=2.5A, Co = 47uF, Scope BW=20MHz)

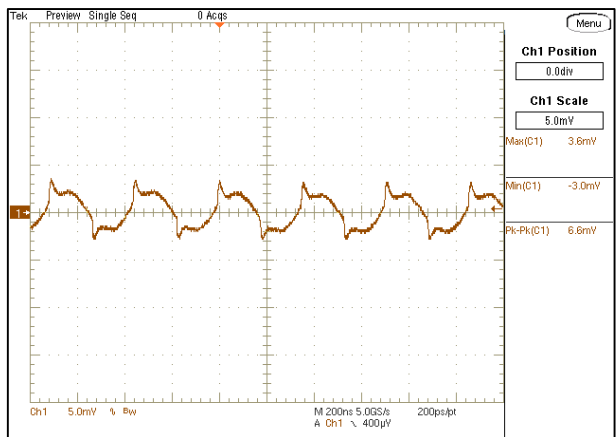

Step Load Transient Response (Vin=12V, Vo=5.25V, Co = 47uF,
Io=1.25A to 2.5A, 2.5A/us) Trace 3=Vo, 20mV/div, Trace 4=Io, 2A/div.

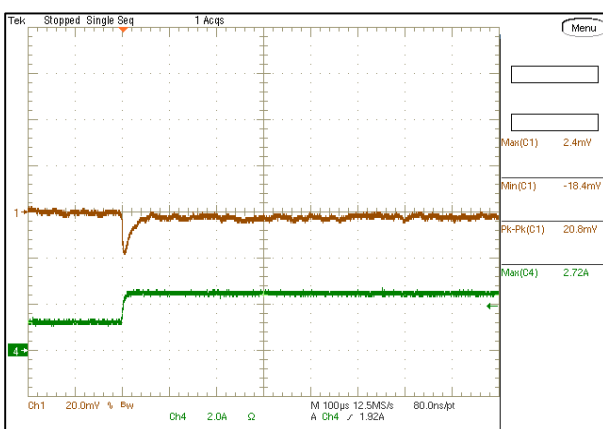

Step Load Transient Response (Vin=12V, Vo=5.25V, Co = 47uF,
Io=1.25A to 2.5A, 2.5A/us) Trace 3=Vo, 20mV/div, Trace 4=Io, 2A/div.

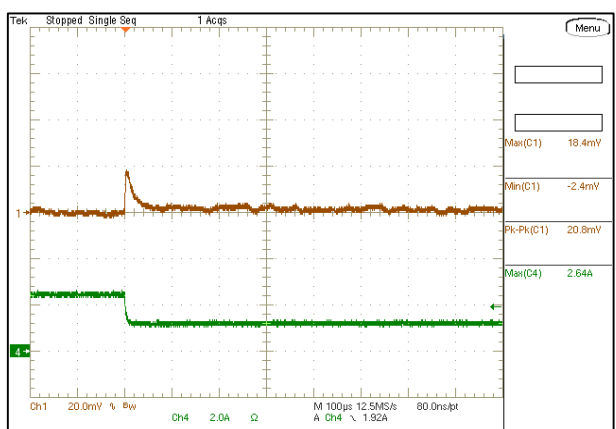

THERMAL DERATING CURVS

Maximum Current Temperature Derating at Sea Level

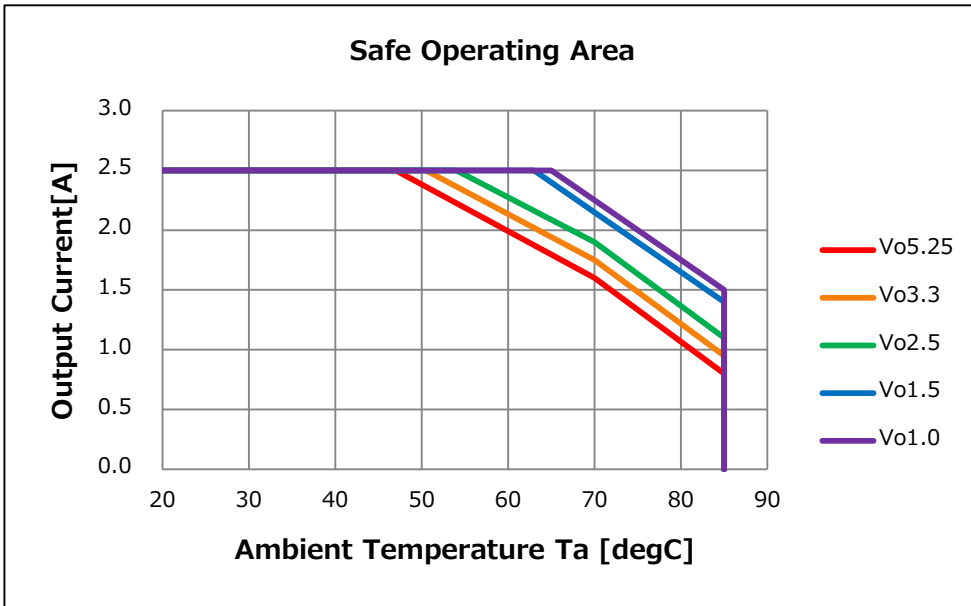

Thermal deratings are evaluated in following condition.

- Input Voltage is 13.2V.
- The products are mounted on 100mm x 50mm x 1.6mm(4 Layer, 1oz copper each)FR-4 board respectively.

MECHANICAL SPECIFICATIO

Dimension and Pin Assignment

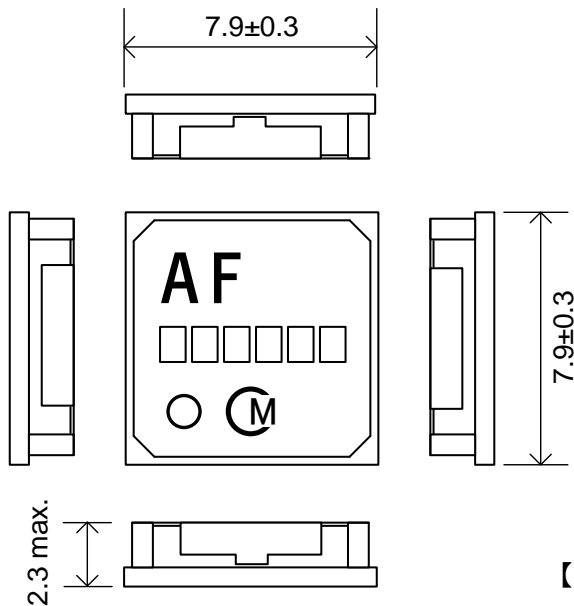

【Unit : mm】

<Bottom View>

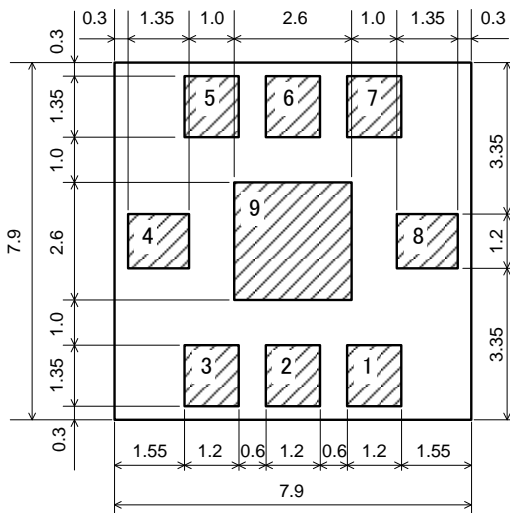

【Unit : mm】

INPUT/OUTPUT CONNECTIONS		
Pin No.	Name	Function
1	VAR	Output Voltage Adjustment
2-3	GND	GND
4	Vin	Input Voltage
5	EN	Enable(ON/OFF)
6	GND	GND
7	Vo	Output Voltage
8	GND	GND
9	G-PAD	GND pad for radiation

Recommended Board Land Pattern (Top View)

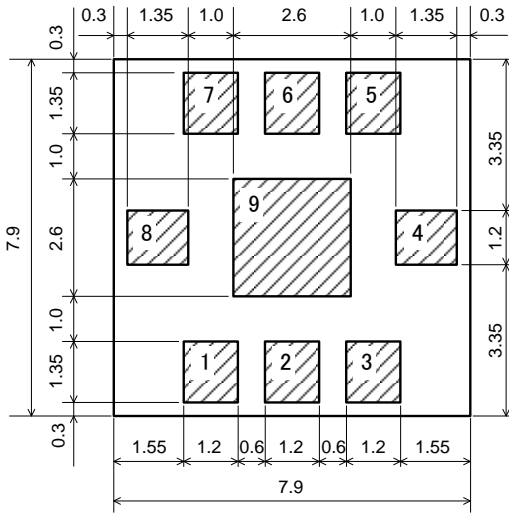

【Unit : mm】

EXAMPLE OF PATTEAN LAYOUT (TOP VIEW)

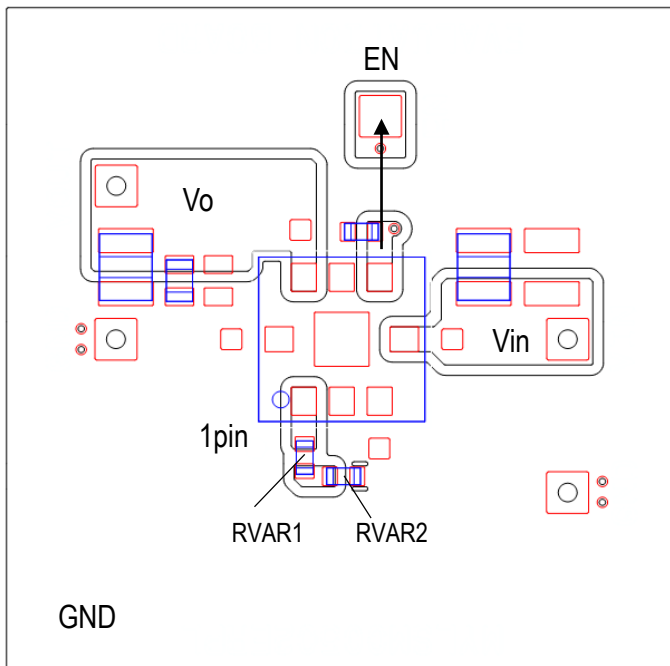

Picture
Top view



Bottom view

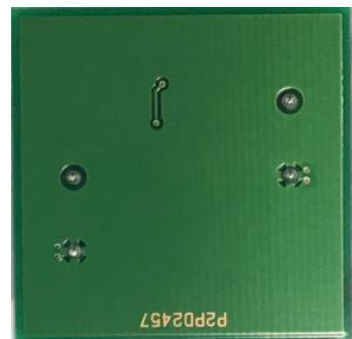

TAPE AND REEL INFORMATION

Tape Dimension

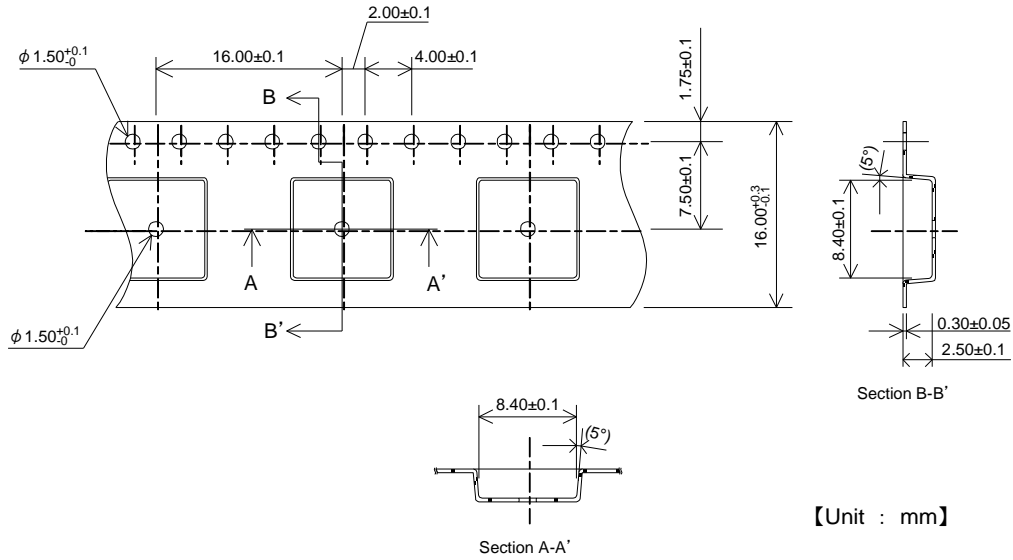

Reel Dimension

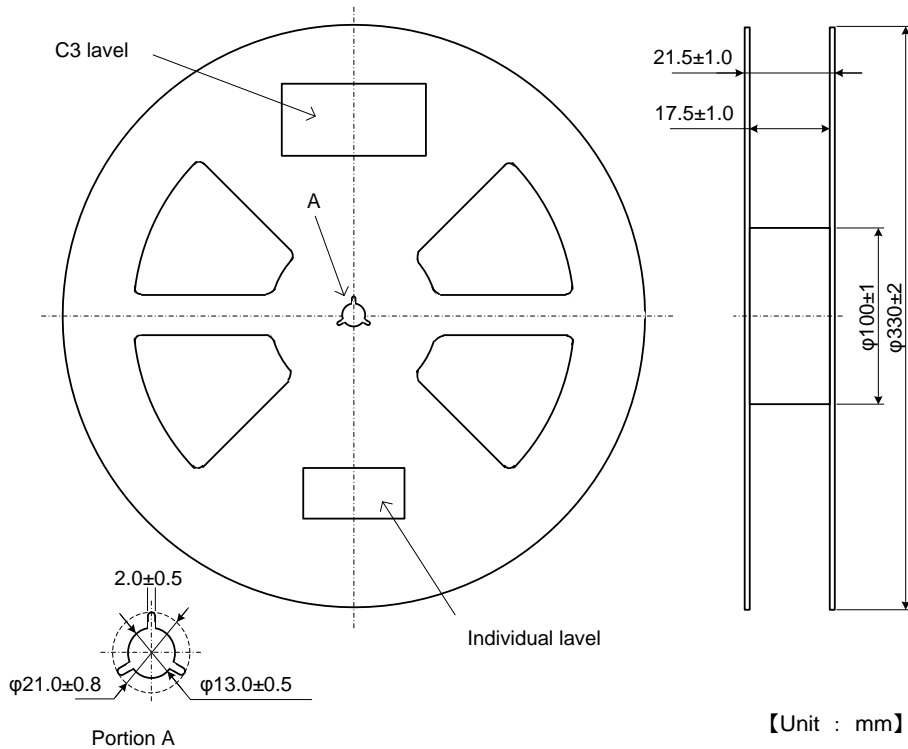

TAPE SPECIFICATION

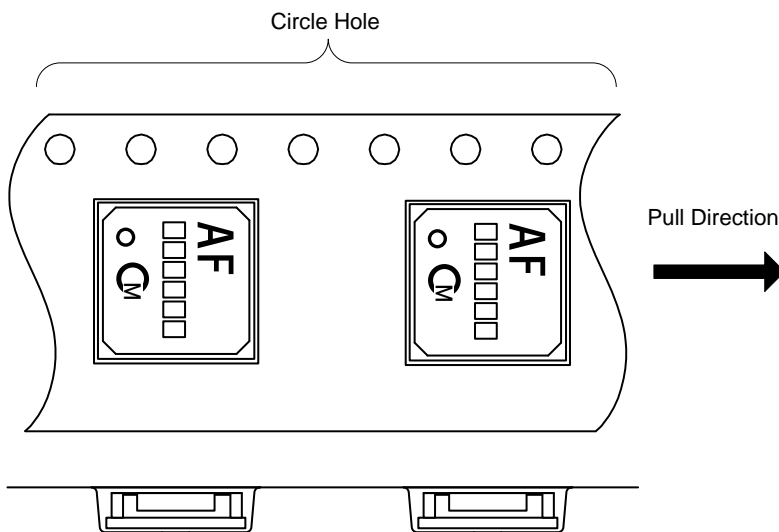
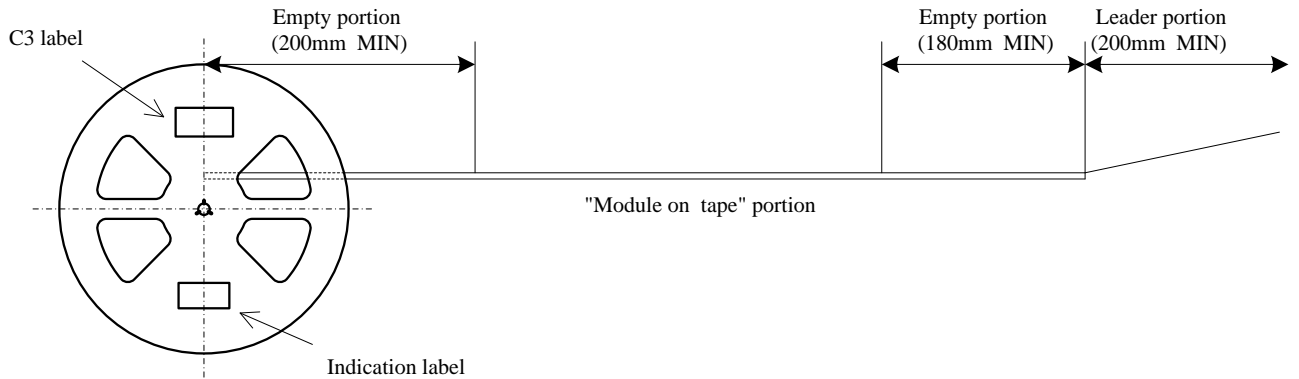

Note

1. The adhesive strength of the protective tape must be within 0.1-1.3N.
2. Each reel contains 1000 pcs.
3. Each reel set in moisture-proof packaging because of MSL 2.
4. No vacant pocket in "Module on tape" section.
5. The reel is labeled with Murata part number and quantity.
6. The color of reel is not specified.

TECHNICAL NOTES

Input Fusing

Certain applications and/or safety agencies may require fuses at the inputs of power conversion components.

Fuses should also be used when there is the possibility of sustained input voltage reversal which is not current limited.

For greatest safety, we recommend a fast blow fuse installed in the ungrounded input supply line. The installer must observe all relevant safety standards and regulations. For safety agency approvals, install the converter in compliance with the end-user safety standard.

Recommended Input Filtering

The user must assure that the input source has low AC impedance to provide dynamic stability and that the input supply has little or no inductive content, including long distributed wiring to a remote power supply. For best performance, we recommend installing a low-ESR capacitor immediately adjacent to the converter's input terminals.

The capacitor should be a ceramic type such as the Murata GRM31 series or GRM21 series and a electrolytic type such as Panasonic OS-CON series. Initial suggested capacitor values are 10uF ceramic type, rated at twice the expected maximum input voltage. Make sure that the input terminals do not go below the under voltage shutdown voltage at all times. More input bulk capacitance may be added in parallel if needed.

Recommended Output Filtering

The converter will achieve its rated output ripple and noise with additional external capacitor. The user may install more external output capacitance reduce the ripple even further or for improved dynamic response.

Initial suggested capacitor values are 47uF ($V_o \leq 2.5V$) or 20uF ($V_o > 2.5V$) ceramic type .

Measure the output ripple under your load conditions.

Use only as much capacitance as required to achieve your ripple and noise objectives. Excessive capacitance can make step load recovery sluggish or possibly introduce instability. Do not exceed the maximum rated output capacitance listed in the specifications.

Output Noise

Output noise is measured as shown in the figures below.

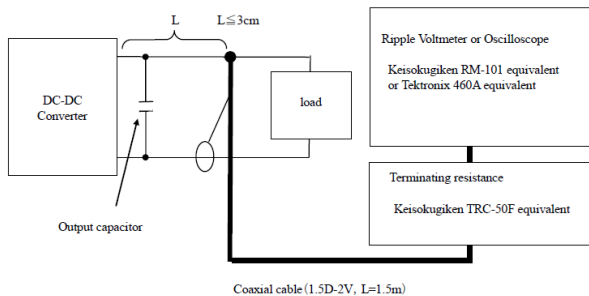

Thermal Shut down

To prevent many over temperature problems and damage, these converters include thermal shutdown circuitry. If environmental conditions cause the temperature of the DC/DC's to rise above the Operating Temperature Range up to the shutdown temperature, an on-board electronic temperature sensor will power down the unit. When the temperature decreases below the turn-on threshold, the converter will automatically restart.

CAUTION: If you operate too close to the thermal limits, the converter may shut down suddenly without warning. Be sure to thoroughly your application to avoid unplanned thermal shutdown.

Minimum Output Loading Requirements

All models regulate within specification and are stable under no load to full load conditions. Operation under no load might however slightly increase output ripple and noise.

Temperature Derating Curves

The graphs in this data sheet illustrate typical operation under a variety of conditions. The derating curves show the maximum continuous ambient air temperature. Note that these are AVERAGE measurements. Note that the temperatures are of the ambient airflow, not the converter itself which is obviously running at higher temperature than the outside air. Also note that very low flow rates (below about 25 LFM) are similar to "natural convection," that is, not using fan-forced airflow. Murata makes Characterization measurements in a closed cycle wind tunnel with calibrated airflow. We use both thermocouples and an infrared camera system to observe thermal performance.

CAUTION: These graphs are all collected at slightly above Sea Level altitude. Be sure to reduce the derating for higher density altitude.

Output Short Circuit Protection

In the case of a heavy overload setting such as a short circuit, the converter temporarily stop output.

Following a time-out period, the converter will restart, causing the output voltage to begin ramping up to its appropriate value. If the short-circuit condition persists, another shutdown cycle will initiate. This rapid on/off cycling is called "hiccup mode". The hiccup cycling reduces the average output current, thereby preventing excessive internal temperatures and/or component damage. A short circuit can be tolerated indefinitely.

The "hiccup" system differs from latching short circuit systems because you do not have to power down the converter to make it restart. The system will automatically restore operation as soon as the short circuit condition is removed.

ENABLE (On/Off) Control

The converter is enabled when EN pin voltage is 0.3V or less.

Please refer to the "FUNCTIONAL SPECIFICATIONS" on page 3 for EN voltage.

Output Capacitive Load

Users should only consider adding capacitance to reduce switching noise and/or to handle spike current load steps. Install only enough capacitance to achieve noise objectives. Excess external capacitance may cause regulation problems, degraded transient response and possible oscillation or instability.

Soldering Guidelines

Murata recommends the specifications below when installing this converter. Exceeding this specifications may cause damage to the product. Your production environment may differ therefore please thoroughly review these guidelines with your process engineers.

Reflow solder operations for surface-mount products	
Solders	Sn/Ag/Cu based
Preheat Temperature	Less than 1degC per second
Reflow Zone ①	
Time Over Liquidus	30 to 75 seconds
Temperature	220degC and more
Reflow Zone ②	
Time Over Liquidus	20 seconds or less
Temperature	250degC and more (*260degC and less)
Cooling Rate	Less than 1degC per second

Recommended Lead-free Solder Reflow Profile

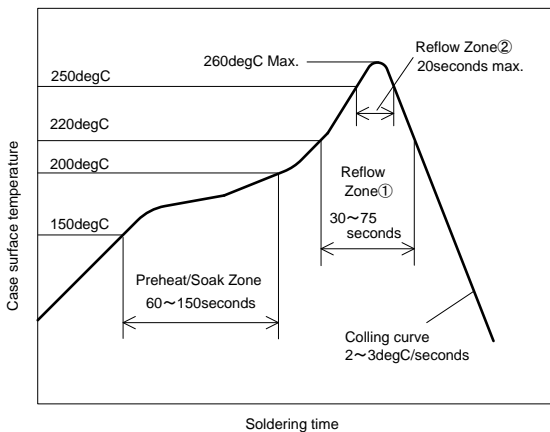

Output Voltage Adjustment

The output voltage may be adjusted over a limited range by connecting an external VAR resistor (RVAR) between the VAR pin and GND pin. The RVAR resistor must be a 1/10W precision metal film type, ±0.5% accuracy or better with low temperature coefficient, ±100 ppm/degC or better.

RVAR resistor value is calculated by the following equation.

$$RVAR = \frac{80}{V_o - 0.8} - 18 \text{ [k}\Omega\text{]}$$

Mount the resistor close to the converter with very short leads or use a surface mount trim resistor.

Do not exceed the specified limits of the output voltage or the converter's maximum power rating when applying these resistors.

Also, avoid high noise at the VAR input. However, to prevent instability, you should never connect any capacitors between VAR pin and GND pin.

CAUTION: Do not change the RVAR while the converter is operating.

TEST Circuit

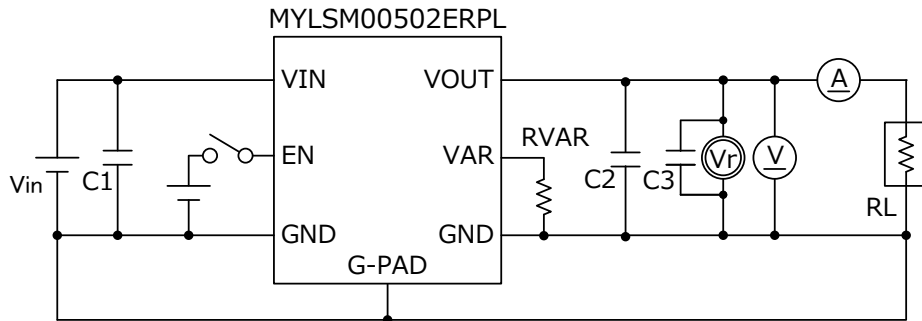

Vin: DC Power Supply

RL: Electronic Load Device

Vr : Ripple Voltmeter RM-101 (Keisokugiken)

C1 : 10 μ F/25V (GRM32DR71E106KA12 ; Murata)

C2 : 47 μ F/6.3V (GRM31CC80J476KE18 ; Murata)

C3 : 0.1 μ F/50V (GRM188R11H104KA93 ; Murata)

Mouser Electronics

Authorized Distributor

Click to View Pricing, Inventory, Delivery & Lifecycle Information:

[Murata:](#)

[MYLSM00502ERPL](#) [MYLSM00502ERPL-EVM](#)