

# MODEL TL-2450

## TECHNICAL DATA

(Typical values @+25°C for batteries stored for one year or less)

- Nominal capacity @ 0.5 mA, to 2V 0.55 Ah
- Rated voltage 3.6 V
- Maximum recommended continuous current 5 mA
- Maximum pulse current capability 10 mA
- Weight 8.8g (0.310 oz)
- Volume 2.60 cc
- Operating temperature range -55°C to +85°C
- Li metal content approx. 0.2 g
- U.L. Component Recognition MH 12193

## TADIRAN LITHIUM BATTERIES

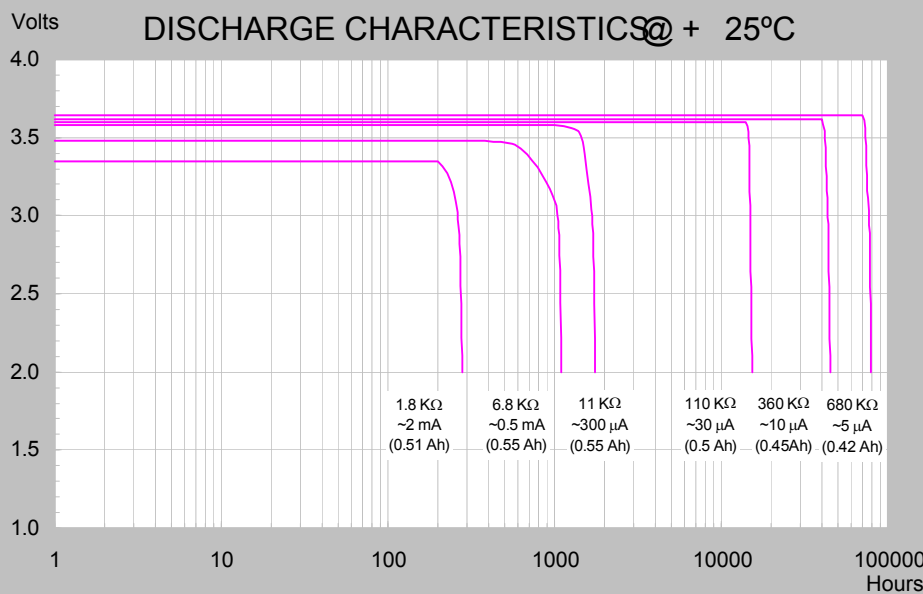
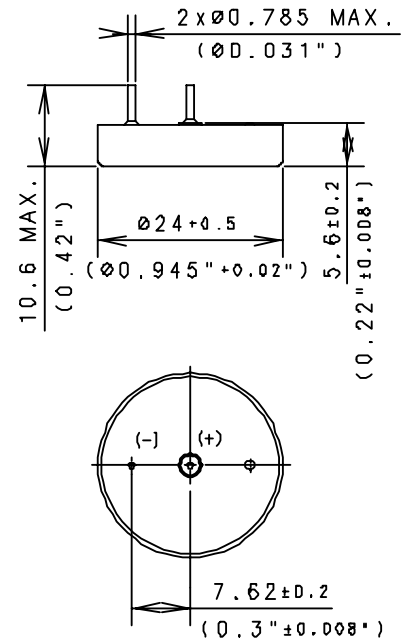

### ADDITIONAL INFORMATION

SUFFIX- /P TIN PLATED NICKEL PINS  
CATALOGUE NO.: 15-2450-41020

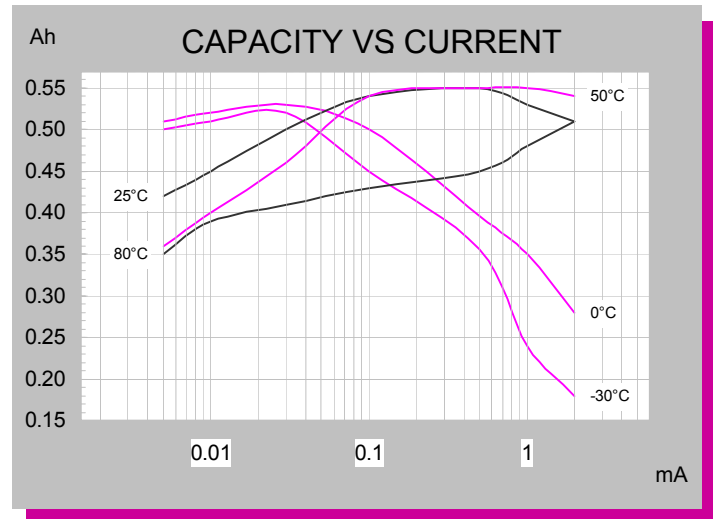
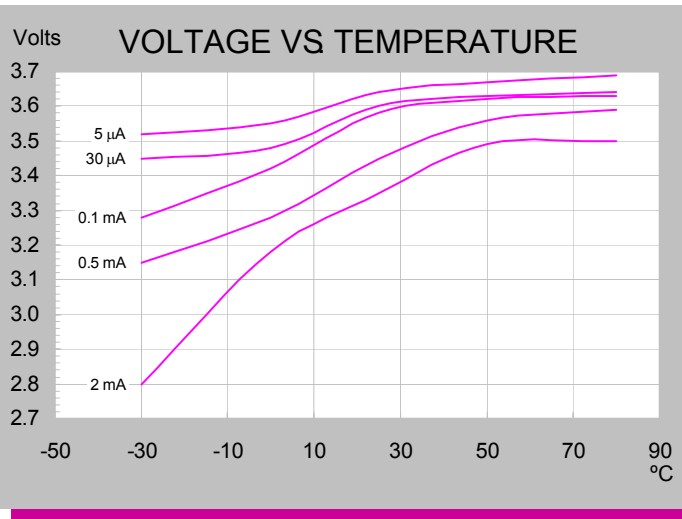

*iXtra - Long Term High Performance*

Note: Any presentations in this data sheet concerning performance are for information purpose only and are not construed as warranties either expressed or implied, of future performance. Rev. B 02/11 ECN 1502262

# TL-2450

## CELL FEATURES

- 3.6 V Primary lithium-thionyl chloride (Li-SOCl<sub>2</sub>)
- Fast voltage recovery after long term storage and/or usage
- High energy density
- High and stable operating voltage
- Low self discharge rate
- 10 years shelf life
- Wafer construction
- Hermetic glass-to-metal-sealing
- Non-flammable electrolyte
- Non-restricted for transportation

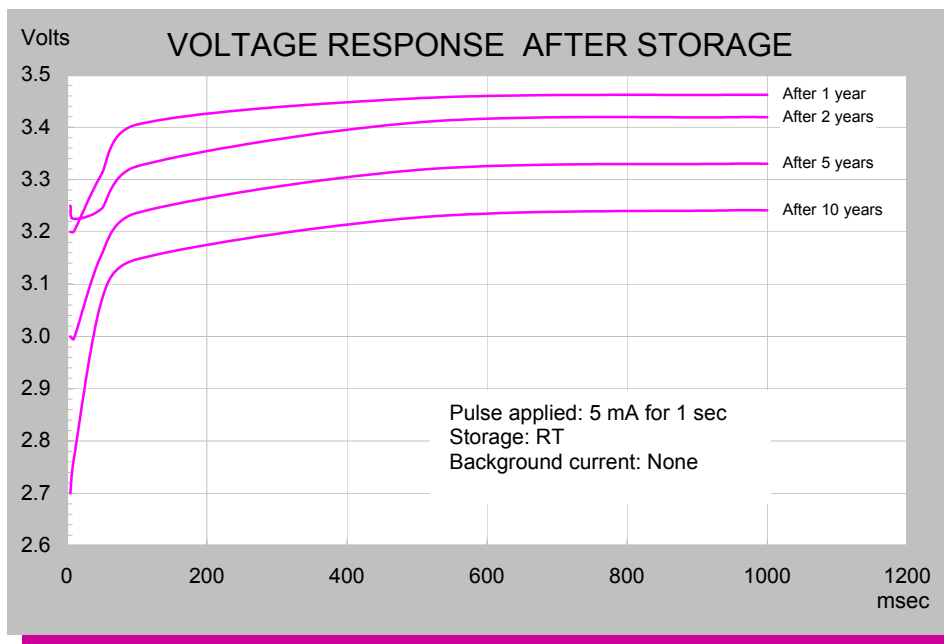

# TADIRAN LITHIUM BATTERIES

## MAIN APPLICATIONS

- Utility meters (elect., water & gas)
- Automatic meter reading
- RF systems
- Sensors & monitoring systems
- Tracking systems
- Wireless security systems
- Automotive electronics
- Industrial electronics
- Ultra Low Power (ULP)

## STORAGE CONDITIONS

- Cells should be stored in a clean & dry (less than 30 % RH) area

For updated information please visit our website [www.tadiranbat.com](http://www.tadiranbat.com)

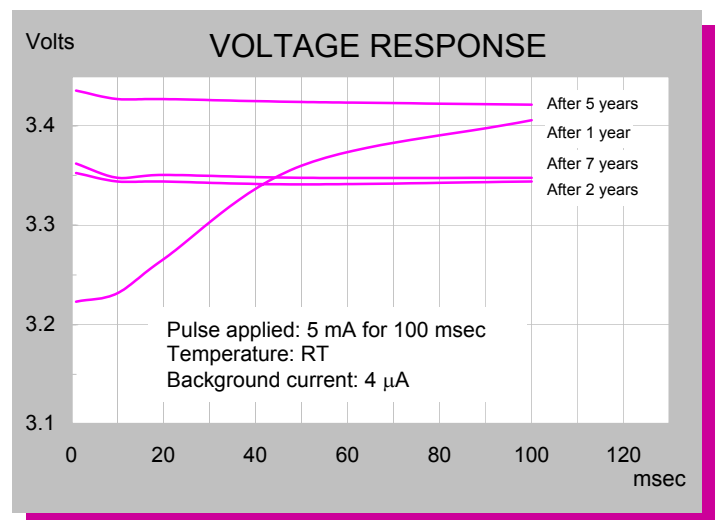
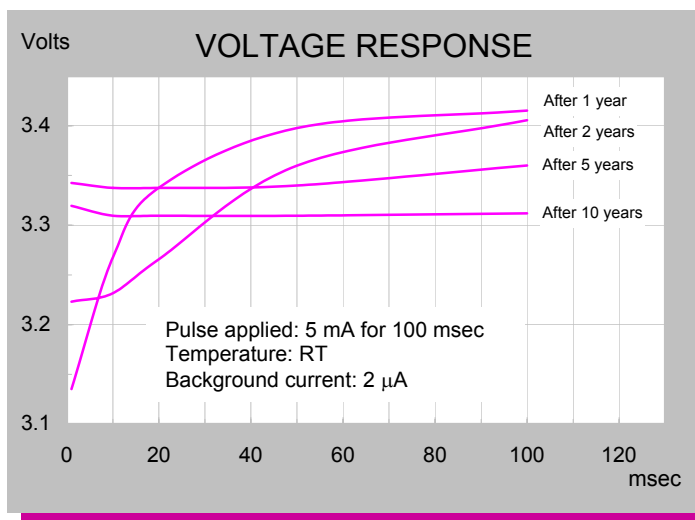

*iXtra - Long Term High Performance*

# Mouser Electronics

Authorized Distributor

Click to View Pricing, Inventory, Delivery & Lifecycle Information:

[Tadiran Batteries:](#)

[TL2450P](#)