

FULLY INTEGRATED Z-WAVE® WIRELESS MODEM WITH ON-BOARD ANTENNA



The Silicon Labs ZM5304 Modem is a fully integrated Z-Wave modem module in a small 27mm x 15.2mm x 5.5mm form factor. It is an ideal solution for home control applications such as access control, appliance control, AV control, building automation, energy management, lighting, security, and sensor networks in the “Internet of Things”.

A baseband controller, sub-1 GHz radio transceiver, crystal, decoupling, SAW filter, matching, and the antenna is included to provide a complete Z-Wave solution to an application executing in an external host microcontroller. The ZM5304 Modem is certified with the FCC modular transmitter approval, ready to be used in any product without additional testing and license costs.

The ZM5304 Modem is based on an 8-bit 8051 CPU core, which is optimized to handle the data and link management requirements of a Z-Wave node. The UART0 or USB interface can be used to access the Z-Wave stack available in the on-chip Flash memory, or to easily upgrade the modem firmware.

FCC ID	D87-ZM5304-U
IC ID	11263A-ZM5304

Features

- Complete Z-Wave stack available over UART or USB
- Firmware upgradeable via UART or USB
- 32kB of byte addressable NVM memory
- Fully Integrated crystal, EEPROM, SAW filter, matching circuit, and antenna
- No external components required
- FCC modular transmitter approval
- ITU G.9959 compliant

Modem

- UART speed up to 230.4kbps
- USB 2.0 full speed
- Z-Wave serial API accessed over UART or USB
- ADC for internal battery monitoring
- Hardware AES-128 security engine
- Power-On-Reset / Brown-out Detector
- Supply voltage range from 2.3V to 3.6V for optional battery operation
- TX mode current typ. 36mA @ 0dBm
- RX mode current typ. 33mA
- Normal mode current typ. 15mA
- Sleep mode current typ. 2µA
- Less than 1ms cold start-up time

Radio Transceiver

- Receiver sensitivity with SAW filter down to -103dBm @ 9.6kbps
- Transmit power with SAW filter up to +4dBm
- Z-Wave 9.6/40/100kbps data rates
- Supports all Z-Wave sub-1 GHz frequency bands (865.2MHz to 926.3MHz)
- Supports multi-channel frequency agility and listen before talk
- Regulatory Compliance
ACMA: AS/NZS 4268
CE: EN 300 220/489
FCC: CFR 47 Part 15
IC: RSS-GEN/210
MIC: ARIB STD-T108

1 CONTENT

2 OVERVIEW 4

2.1 PERIPHERALS..... 4

2.1.1 *Advanced Encryption Standard Security Processor* 4

2.1.2 *Analog-to-Digital Converter* 5

2.1.3 *Brown-Out Detector / Power-On-Reset*..... 5

2.1.4 *Crystal Driver and System Clock* 5

2.1.5 *Universal Asynchronous Receiver / Transmitter* 5

2.1.6 *Universal Serial Bus*..... 5

2.1.7 *Watchdog*..... 6

2.1.8 *Wireless Transceiver*..... 6

2.2 MEMORY MAP..... 6

2.3 MODULE PROGRAMMING..... 7

2.3.1 *Entering In-System Programming Mode*..... 7

2.3.2 *Entering Auto Programming Mode*..... 7

2.4 POWER SUPPLY REGULATOR 7

3 TYPICAL APPLICATION 8

4 PIN CONFIGURATION 9

4.1 PIN FUNCTIONALITY..... 9

5 ELECTRICAL CHARACTERISTICS..... 11

5.1 TEST CONDITIONS 11

5.1.1 *Typical Values*..... 11

5.1.2 *Minimum and Maximum Values*..... 11

5.2 ABSOLUTE MAXIMUM RATINGS 12

5.3 GENERAL OPERATING RATINGS..... 12

5.4 CURRENT CONSUMPTION 12

5.5 SYSTEM TIMING..... 13

5.6 NON-VOLATILE MEMORY RELIABILITY..... 14

5.7 ANALOG-TO-DIGITAL CONVERTER..... 14

5.8 DC CHARACTERISTICS 15

5.9 RF CHARACTERISTICS..... 16

5.9.1 *Transceiver*..... 16

5.9.2 *Antenna*..... 16

5.9.3 *Regulatory Compliance* 23

6 Z-WAVE FREQUENCIES 24

7 MODULE INFORMATION..... 25

7.1 MODULE MARKING 25

7.2 MODULE DIMENSIONS 25

8 PROCESS SPECIFICATION..... 26

9 PCB MOUNTING AND SOLDERING..... 26

9.1 PCB MOUNTING PATTERN 26

9.2 RECOMMENDED PLACEMENT ON PCB 27

9.3 SOLDERING INFORMATION 27

9.4 VISUAL INFORMATION 28

10 ORDERING INFORMATION 29

10.1 TAPE AND REEL INFORMATION 30

10.2 CANADA IC STATEMENT 32

11 ABBREVIATIONS..... 34

12 REVISION HISTORY 36

13 REFERENCES..... 38

Not Recommended for New Designs

2 OVERVIEW

The ZM5304 Modem is a fully integrated module with an on-board antenna that allows the establishment of a Z-Wave network with minimum risk. The SD3503 modem chip is used with an external NVM (EEPROM), 32MHz crystal, power supply decoupling, SAW filter, matching circuit, and a helical antenna. Figure 2.1 shows the main blocks of the ZM5304 Modem, while Figure 2.2 illustrates the firmware stack of an example application.

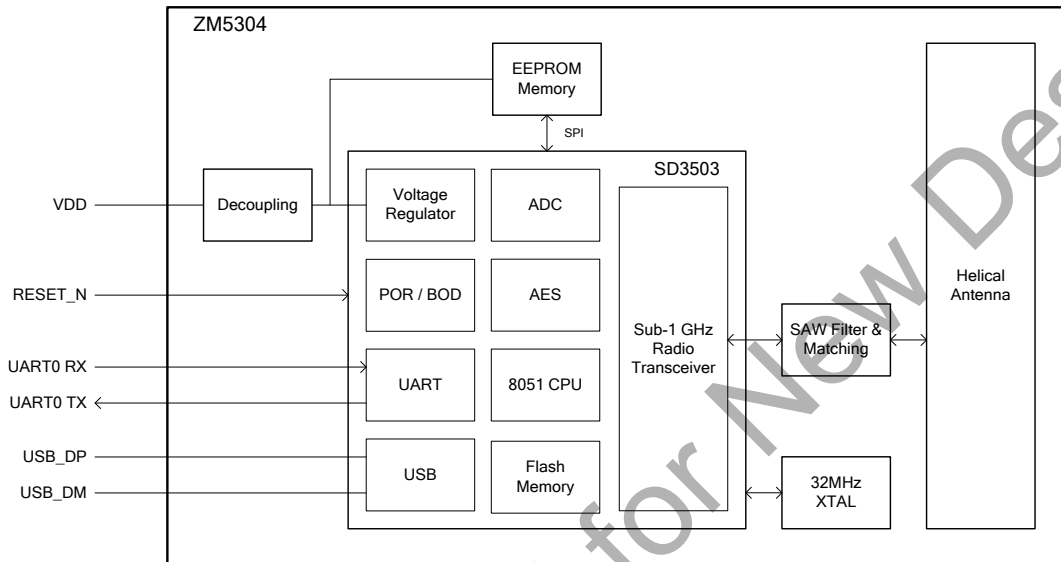

Figure 2.1: Functional block diagram

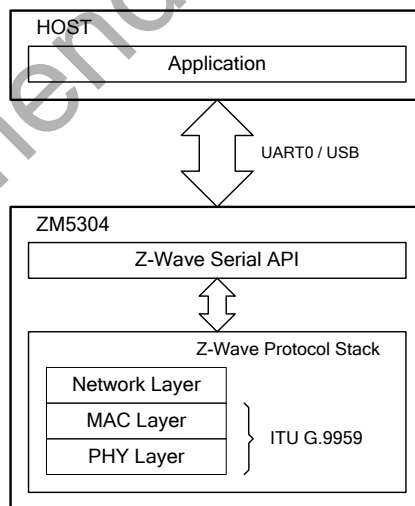

Figure 2.2: Firmware stack

2.1 PERIPHERALS

2.1.1 ADVANCED ENCRYPTION STANDARD SECURITY PROCESSOR

The Z-Wave protocol specifies the use of Advanced Encryption Standard (AES) 128-bit block encryption for secure applications. The built-in Security Processor is a hardware accelerator that encrypts and decrypts data at a rate of 1 byte per 1.5µs. It encodes

the frame payload and the message authentication code to ensure privacy and authenticity of messages. The processor supports Output FeedBack (OFB), Cipher-Block Chaining (CBC), and Electronic CodeBook (ECB) modes to target variable length messages. Payload data is streamed in OFB mode, and authentication data is processed in CBC mode as required by the Z-Wave protocol. The processor implements two efficient access methods: Direct Memory Access (DMA) and streaming through Special Function Register (SFR) ports. The processor functionality is exposed via the Z-Wave API for application use.

2.1.2 ANALOG-TO-DIGITAL CONVERTER

The Analog-to-Digital Converter (ADC) is capable of sampling an input voltage source and returns an 8- or 12-bit unsigned representation of the input scaled relative to the selected reference voltage. It can be configured to implement a battery monitor, as described by the formula below.

$$ADC_{OUT} = \frac{V_{BG}}{V_{DD}} \times 2^{Number\ of\ bits}$$

The ADC is capable of operating rail to rail, where the built-in Band-gap $V_{BG} = 1.25V$ and V_{DD} is the supply voltage. When the supply voltage crosses a predefined lower or upper voltage threshold, an interrupt can be triggered.

2.1.3 BROWN-OUT DETECTOR / POWER-ON-RESET

When a cold start-up occurs, an internal Power-On-Reset (POR) circuit ensures that code execution does not begin unless the supply voltage is sufficient. After which, an internal Brown-Out Detector (BOD) circuit guarantees that faulty code execution does not occur by entering the reset state, if the supply voltage drops below the minimum operating level. These guarantees apply equally in both the active and sleep modes.

2.1.4 CRYSTAL DRIVER AND SYSTEM CLOCK

The system clock and RF frequencies are derived from the module mounted 32MHz crystal (XTAL), which internal system performance is factory trimmed to guarantee initial RF frequency precision.

2.1.5 UNIVERSAL ASYNCHRONOUS RECEIVER / TRANSMITTER

The Universal Asynchronous Receiver / Transmitter (UART) is a hardware block operating independently of the 8051 CPU. It offers full-duplex data exchange, up to 230.4kbps, with an external host microcontroller requiring an industry standard NRZ asynchronous serial data format. The UART0 interface is available over pin 4 and pin 5 (refer section 4). A data byte is shifted as a start bit, 8 data bits (lsb first), and a stop bit, respectively, with no parity and hardware handshaking. Figure 2.3 shows the waveform of a single serial byte. UART0 is compliant with RS-232 when an external level converter is used.

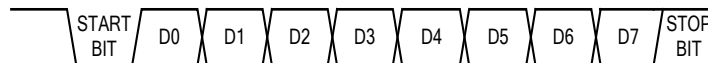

Figure 2.3: UART0 waveform

2.1.6 UNIVERSAL SERIAL BUS

A Universal Serial Bus (USB) 2.0 full speed interface is available over pin 6 and pin 7 (refer section 4). The Communication Device Class / Abstract Control Mode (CDC/ACM) provides an emulated virtual COM port to a host. This makes it easy to migrate from legacy RS-232 communication to USB communication. Figure 2.4 shows the two termination resistors necessary to maintain signal integrity of the differential pair and a single pull-up resistor on USB_DP, which indicates a full speed device to the host.

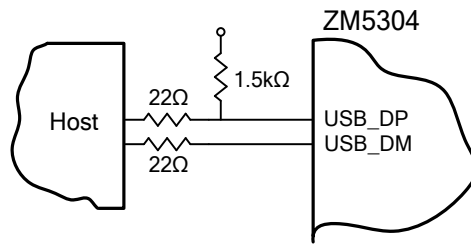

Figure 2.4: USB interface

The controller supports USB suspend mode and remote wake-up. During suspend mode, except for the crystal oscillator clocking at a slower rate and the active USB controller, the entire CPU is powered off. The USB controller uses the DMA for fast data transfer and automatic data retransmissions/CRC to maintain data integrity.

2.1.7 WATCHDOG

The watchdog helps prevent the CPU from entering a deadlock state. A timer that is enabled by default achieves this by triggering a reset event in case it overflows. The timer overflows in 1 second, therefore it is essential that the software clear the timer periodically. The watchdog is disabled when the chip is in power down mode, and automatically restarts with a cleared timer when waking up to the active mode.

2.1.8 WIRELESS TRANSCIVER

The wireless transceiver is a sub-1 GHz ISM narrowband FSK radio, a modem, and a baseband controller. This architecture provides an all-digital direct synthesis transmitter and a low IF digital receiver. The Z-Wave protocol currently utilizes 2-key FSK/GFSK modulation schemes at 9.6/40/100 kbps data rates throughout a span of carrier frequencies from 865.2MHz to 926.3MHz.

The output power of the transmitter is configurable in the range -26dBm to +4dBm ($V_{DD} = +2.3V$ to $+3.6V$, $T_A = -10^{\circ}C$ to $+85^{\circ}C$).

2.2 MEMORY MAP

An application executing on an external host microcontroller can access the higher address space of the integrated EEPROM via the serial API. As shown in Figure 2.5, the protocol data is stored in the lower address space. A serial API function returns the size of the application data space. [1][2]

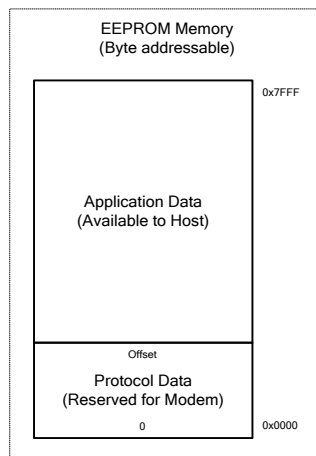

Figure 2.5: EEPROM memory map

2.3 MODULE PROGRAMMING

The firmware of the ZM5304 Modem can be upgraded either via UART0 or USB interface. [3] In-System Programming is the default mode delivered from the factory.

2.3.1 ENTERING IN-SYSTEM PROGRAMMING MODE

The module can be placed into the UART0 In-System Programming (ISP) mode by asserting the active low RESET_N signal for 5.2ms. The programming unit of the module then waits for the “Interface Enable” serial command before activating the ISP mode over UART0.

2.3.2 ENTERING AUTO PROGRAMMING MODE

Alternatively, the module can be placed into the Auto Programming Mode (APM) by calling a serial API function. The programming unit of the module will enter APM immediately after a hardware or software reset. Once the module is in APM, the firmware can be written to the internal flash using either the UART0 or USB interface.

2.4 POWER SUPPLY REGULATOR

While the supply to the digital I/O circuits is unregulated, on-chip low-dropout regulators derive all the 1.5 V and 2.5 V internal supplies required by the Micro-Controller Unit (MCU) core logic, non-volatile data registers, flash, and the analogue circuitry.

3 TYPICAL APPLICATION

An illustration of two application examples using the ZM5304 Modem implementation follows. The host application located on an external microcontroller accesses the Z-Wave stack via the serial API. Figure 3.1 depicts the scenario when UART0 is used as the primary interface to the ZM5304 Modem, while Figure 3.2 shows the scenario when the USB¹ is used. In the latter scenario, UART0 must be routed out to test points in order to program the initial firmware during production. It is strongly recommended that the power supply is decoupled sufficiently.

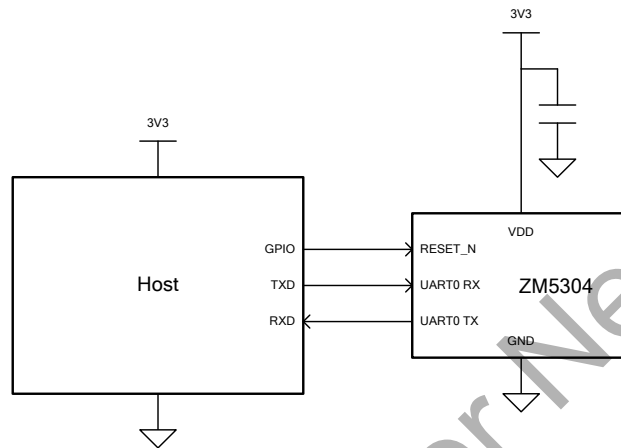

Figure 3.1: Example of a host microcontroller based application using UART0

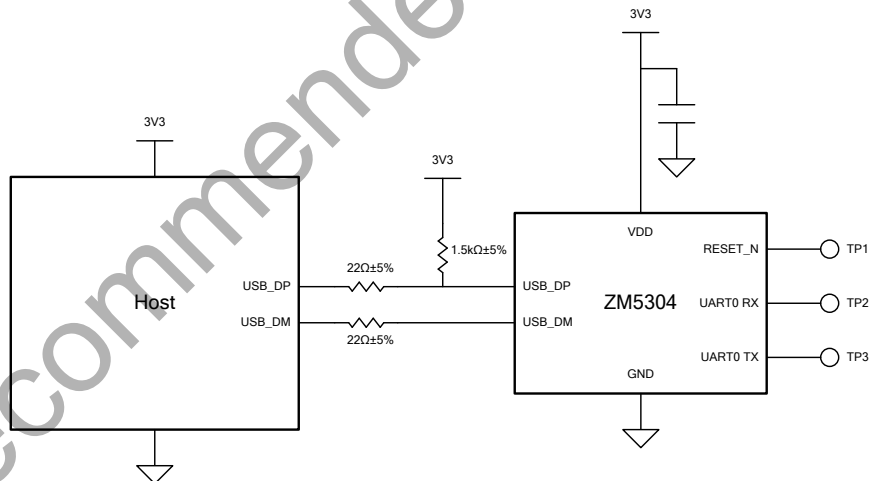

Figure 3.2: Example of a host microcontroller based application using the USB

¹ Firmware upgrades can be performed only when the ZM5304 Modem is placed in APM.

4 PIN CONFIGURATION

The layout of the pins on the ZM5304 Modem is shown in Figure 4.1.

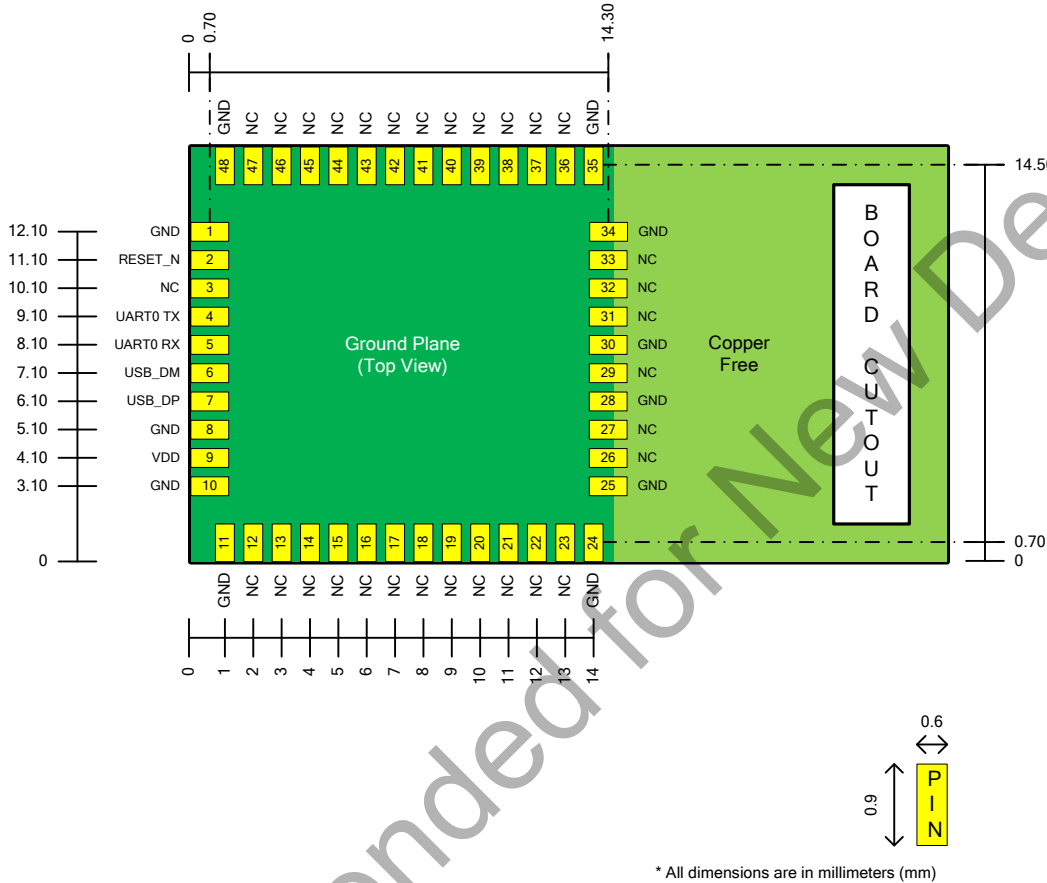

Figure 4.1: Pin layout (top view)

4.1 PIN FUNCTIONALITY

Table 4.1: Power, ground, and no connect signals

Pin Name	Pin Location	Type ²	Function
V _{DD}	9	S	Module power supply.
GND	1, 8, 10, 11, 24, 25, 28, 30, 34, 35, 48	S	Ground. Must be connected to the ground plane.
NC	3, 12, 13, 14, 15, 16, 17, 18, 19, 20, 21, 22, 23, 26, 27, 29, 31, 32, 33, 36, 37, 38, 39, 40, 41, 42, 43, 44, 45, 46, 47	-	Placement pins for mechanical stability. Leave unconnected.

² I = Input, O = Output, D+ = Differential Plus, D- = Differential Minus, S = Supply

Table 4.2: Module control signals

Pin Name	Pin Location	Type	Function
RESET_N	2	I	Active low signal that places the module in a reset state.

Table 4.3: UART0 interface signals

Pin Name	Pin Location	Type	Function in Reset State	Function in Active State
UART0 RX	5	I	Waits for the “Interface Enable” serial command after 5.2ms. Enters UART0 ISP mode after command is received from the host.	Receive data from host serial port.
UART0 TX	4	O	Serial data transmit when in UART0 ISP mode, high impedance with internal pull-up otherwise.	Transmit data to host serial port.

Table 4.4: USB interface signals

Pin Name	Pin Location	Type	Function in Reset State	Function in Active State
USB_DP	7	D+	ISP when in APM mode, high impedance with internal pull-up otherwise.	USB 2.0 full-speed positive differential signal.
USB_DM	6	D-	ISP when in APM mode, high impedance with internal pull-up otherwise.	USB 2.0 full-speed negative differential signal.

5 ELECTRICAL CHARACTERISTICS

This section describes the electrical parameters of the ZM5304 Modem module.

5.1 TEST CONDITIONS

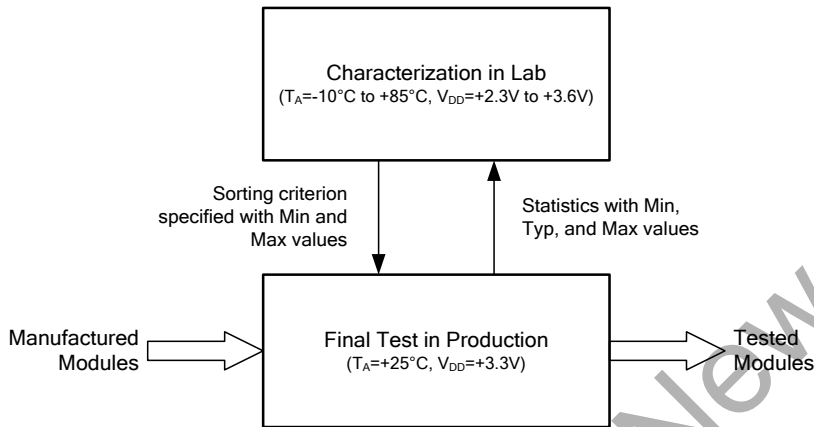

Figure 5.1: Testing flow

The following conditions apply for characterization in the lab, unless otherwise noted.

1. Ambient temperature $T_A = -10^\circ\text{C}$ to $+85^\circ\text{C}$
2. Supply voltage $V_{DD} = +2.3\text{V}$ to $+3.6\text{V}$
3. All tests are carried out on the ZDB5304 Z-Wave Development Board. [4]
4. Total radiated power is measured for 868.4, 908.4, and 921.4MHz

The following conditions apply for the final test in production, unless otherwise noted.

1. Ambient temperature $T_A = +25^\circ\text{C}$
2. Supply voltage $V_{DD} = +3.3\text{V}$
3. Near-field radiated transmission power is measured for 868.4, 908.4, and 921.4MHz
4. Near-field radiated receiver sensitivity is measured for 868.4, 908.4, and 921.4MHz

5.1.1 TYPICAL VALUES

Unless otherwise specified, typical data refer to the mean of a data set measured at an ambient temperature of $T_A=25^\circ\text{C}$ and supply voltage of $V_{DD}=+3.3\text{V}$.

5.1.2 MINIMUM AND MAXIMUM VALUES

Unless otherwise specified the minimum and maximum values are guaranteed in the worst conditions of ambient temperature, supply voltage and frequencies by a final test in production on 100% of the devices at an ambient temperature of $T_A=25^\circ\text{C}$ and supply voltage of $V_{DD}=+3.3\text{V}$.

For data based on measurements, the minimum and maximum values represent the mean value plus or minus three times the standard deviation ($\mu \pm 3\sigma$).

5.2 ABSOLUTE MAXIMUM RATINGS

The absolute ratings specify the limits beyond which the module may not be functional. Exposure to absolute maximum conditions for extended periods may cause permanent damage to the module.

Table 5.1: Voltage characteristics

Symbol	Description	Min	Max	Unit
V _{DD}	Main supply voltage	-0.3	+3.6	V
V _{IN}	Voltage applied on any I/O pin	-0.3	+3.6	V
I _{IN}	Current limit when over driving the input (V _{IN} > V _{DD})	-	+20.0	mA
ESD _{HBM}	JEDEC JESD22-A114F Human Body Model	-	+2000.0	V
ESD _{MM}	JEDEC JESD22-A115C Machine Model	-	+200.0	V
ESD _{CDM}	JEDEC JESD22-C101E Field-Induced Charged-Device Model	-	+500.0	V

Table 5.2: Current characteristics

Symbol	Description	Min	Max	Unit
I _{VDD}	Current into VDD power supply pin	-	+120	mA
I _{GND}	Sum of the current out of all GND ground pins	-120	-	mA

Table 5.3: Thermal characteristics

Symbol	Description	Min	Max	Unit
T _J	Junction temperature	-55	+125	°C

5.3 GENERAL OPERATING RATINGS

The operating ratings indicate the conditions where the module is guaranteed to be functional.

Table 5.4: Recommended operating conditions

Symbol	Description	Min	Typ	Max	Unit
V _{DD}	Standard operating supply voltage	+2.3	+3.3	+3.6	V
V _{DD_USB}	Standard operating supply voltage when USB PHY is used	+3.0	+3.3	+3.6	V
f _{SYS}	Internal clock frequency	-	32.0	-	MHz
T _A	Ambient operating temperature	-10.0	+25.0	+85.0	°C

5.4 CURRENT CONSUMPTION

Measured at an ambient temperature of T_A=-10°C to +85°C and a supply voltage of V_{DD}=+2.3V to +3.6V.

Table 5.5: Current consumption in active modes

Symbol	Description	Min	Typ	Max	Unit
I _{DD_ACTIVE}	MCU running at 32MHz	-	14.8	15.8	mA
I _{DD_RX}	MCU and radio receiver active	-	32.7	35.0	mA
I _{DD_TX_01}	MCU and radio transmitter active, RFPOW=01	-	27.7	-	mA
I _{DD_TX_63}	MCU and radio transmitter active, RFPOW=63	-	42.7	-	mA

Table 5.6: Current consumption in power saving modes

Symbol	Description	Min	Typ	Max	Unit
I _{DD_SLEEP}	Module in sleep state	-	1.7	3.7	μA
I _{USB_SLEEP}	USB suspend mode with state persistency, and system clock	-	2.0	2.3	mA

Table 5.7: Current consumption during programming

Symbol	Description	Min	Typ	Max	Unit
I _{DD_PGM_UART0}	Programming via UART0	-	15	-	mA
I _{DD_PGM_USB}	Programming via USB	-	15	-	mA

5.5 SYSTEM TIMING

Measured at an ambient temperature of T_A=-10°C to +85°C and a supply voltage of V_{DD}=+2.3V to +3.6V.

Table 5.8: Transition between operating modes

Symbol	Description	Min	Typ	Max	Unit
t _{ACTIVE_SLEEP}	Transition time from the active state to the sleep state	-	-	125	ns
t _{SLEEP_ACTIVE}	Transition time from the sleep state to the active state ready to execute code	-	-	160	μs

Table 5.9: System start-up time

Symbol	Description	Min	Typ	Max	Unit
V _{POR}	Power-on-Reset (POR) threshold on rising supply voltage at which the reset signal is deasserted	-	-	+2.3	V
t _{RESET_ACTIVE}	Transition time from the reset state to the active state ready to execute code with a power rise time not exceeding 10μs	-	-	1.0	ms

Table 5.10: Reset timing requirements

Symbol	Description	Min	Typ	Max	Unit
t _{TRST_PULSE}	Duration to assert RESET_N to guarantee a full system reset	20	-	-	ns

Table 5.11: Programming time

Symbol	Description	Min	Typ	Max	Unit
t_{ERASE_FULL}	Time taken to erase the entire flash memory	-	-	44.1	ms
$t_{PGM_FULL_UART0}$	Time taken to program the entire flash memory over UART0 including a full erase	-	-	16.2	s

5.6 NON-VOLATILE MEMORY RELIABILITY

Qualified for an ambient temperature of $T_A=+25^{\circ}C$ and a supply voltage of $V_{DD}=+3.3V$. The on-chip memory is based on SuperFlash® technology.

Table 5.12: On-chip flash

Symbol	Description	Min	Typ	Max	Unit
END_{FLASH}	Endurance, erase cycles before failure	10000	-	-	cycles
$RET_{FLASH-LT}$	Data retention	100	-	-	years
$RET_{FLASH-HT}$	Data retention (Qualified for a junction temperature of $T_J=-10^{\circ}C$ to $+85^{\circ}C$)	10	-	-	years

Table 5.13: On-chip high endurance NVM

Symbol	Description	Min	Typ	Max	Unit
END_{NVM}	Endurance, erase cycles before failure	100000	-	-	cycles
RET_{NVM-LT}	Data retention	100	-	-	years
RET_{NVM-HT}	Data retention (Qualified for a junction temperature of $T_J=-10^{\circ}C$ to $+85^{\circ}C$)	10	-	-	years

Table 5.14: EEPROM

Symbol	Description	Min	Typ	Max	Unit
END_{EEPROM}	Endurance, erase cycles before failure	1Mil	-	-	cycles
RET_{EEPROM}	Data retention	100	-	-	years

5.7 ANALOG-TO-DIGITAL CONVERTER

Measured at an ambient temperature of $T_A=-10^{\circ}C$ to $+85^{\circ}C$ and a supply voltage of $V_{DD}=+2.3V$ to $+3.6V$.

Table 5.15: 12-bit ADC characteristics

Symbol	Description	Min	Max	Unit
V_{BG}	Internal reference voltage	+1.20	+1.30	V
DNL_{ADC}	Differential non-linearity	-1.00	+1.00	LSB
ACC_{8b}	Accuracy when sampling 20ksps with 8-bit resolution	-2.00	2.00	LSB
ACC_{12b}	Accuracy when sampling 10ksps with 12-bit resolution	-5.00	5.00	LSB
f_{s-8b}	8-bit sampling rate	-	0.02	MSPS
f_{s-12b}	12-bit sampling rate	-	0.01	MSPS

5.8 DC CHARACTERISTICS

Measured at an ambient temperature of $T_A = -10^{\circ}C$ to $+85^{\circ}C$.

Table 5.16: Digital input characteristics, supply voltage of $V_{DD} = +2.3V$ to $+3.0V$

Symbol	Description	Min	Max	Unit
V_{IH}	Logical 1 input voltage high level	+1.85	-	V
V_{IL}	Logical 0 input voltage low level	-	+0.75	V
V_{IF}	Falling input trigger threshold	+0.75	+1.05	V
V_{IR}	Rising edge trigger threshold	+1.35	+1.85	V
V_{HYS}	Schmitt trigger voltage hysteresis	+0.55	+0.85	V
I_{IH}	Logical 1 input high level current leakage	-	+7.00	μA
I_{IL-NPU}	Logical 0 input low level current leakage (no internal pull-up resistor)	-7.00	-	μA
I_{IL-PU}	Logical 0 input low level current leakage (with internal pull-up resistor)	+35.00	+90.00	μA
PU_{IN}	Internal pull-up resistance ($T_A = +25^{\circ}C$)	20.00	30.00	k Ω
C_{IN}	Pin input capacitance	-	15.00	pF

Table 5.17: Digital output characteristics, supply voltage of $V_{DD} = +2.3V$ to $+3.0V$

Symbol	Description	Min	Max	Unit
V_{OH}	Logical 1 output voltage high level	+1.9	-	V
V_{OL}	Logical 0 output voltage low level	-	+0.4	V
I_{OH-LP}	Logical 1 output high level current sourcing	-	+6.0	mA
I_{OL-LP}	Logical 0 output low level current sinking	-6.0	-	mA

Table 5.18: Digital input characteristics, supply voltage of $V_{DD}=+3.0V$ to $+3.6V$

Symbol	Description	Min	Max	Unit
V_{IH}	Logical 1 input voltage high level	+2.10	-	V
V_{IL}	Logical 0 input voltage low level	-	+0.90	V
V_{IF}	Falling input trigger threshold	+0.90	+1.30	V
V_{IR}	Rising edge trigger threshold	+1.60	+2.10	V
V_{HYS}	Schmitt trigger voltage hysteresis	+0.65	+0.95	V
I_{IH}	Logical 1 input high level current leakage	-	+10.00	μA
I_{IL-NPU}	Logical 0 input low level current leakage (no internal pull-up resistor)	-10.00	-	μA
I_{IL-PU}	Logical 0 input low level current leakage (with internal pull-up resistor)	+40.00	+120.00	μA
P_{UIN}	Internal pull-up resistance ($T_A=+25^\circ C$)	15.00	20.00	k Ω
C_{IN}	Pin input capacitance	-	15.00	pF

Table 5.19: Digital output characteristics, supply voltage of $V_{DD}=+3.0V$ to $+3.6V$

Symbol	Description	Min	Max	Unit
V_{OH}	Logical 1 output voltage high level	+2.4	-	V
V_{OL}	Logical 0 output voltage low level	-	+0.4	V
I_{OH-LP}	Logical 1 output high level current sourcing	-	+8.0	mA
I_{OL-LP}	Logical 0 output low level current sinking	-8.0	-	mA

5.9 RF CHARACTERISTICS

5.9.1 TRANSCEIVER

The radio transceiver of the ZM5304 is based on the SD3503 modem chip and an external SAW filter. Refer to [5] for measurements on the conducted performance of the SD3503. Although the crystal is factory calibrated, it is mandatory to calibrate the transmitter in production. Refer to [6] for more information.

5.9.2 ANTENNA

The radiation measurements for the ZM5304 were performed on the ZDP03A Z-Wave Development Platform. [7] The orientation of the ZM5304 during the measurements is shown in Figure 5.2.

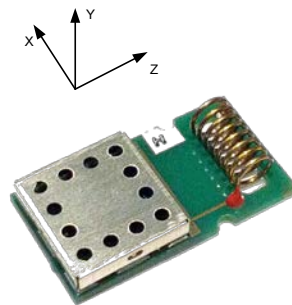

Figure 5.2: Measurement orientation

5.9.2.1 REGION E

Table 5.20: Region E performance

Symbol	Description	Min	Typ	Max	Unit
f_c	Carrier frequency	-	868.40	-	MHz
TRP	Total radiated power	-	-3.05	-	dBm
ε_R	Radiation efficiency	-	-7.05	-	dB
D	Directivity	-	3.47	-	dBi
G	Peak gain	-	-3.58	-	dBi

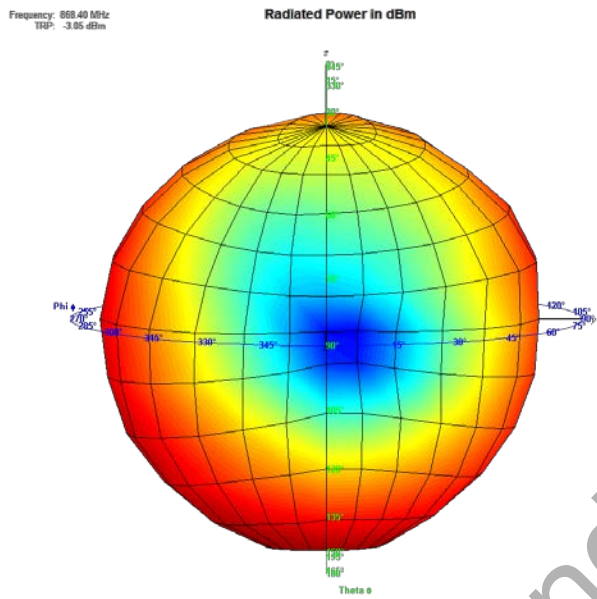

Figure 5.3: YZ plane (X front view)

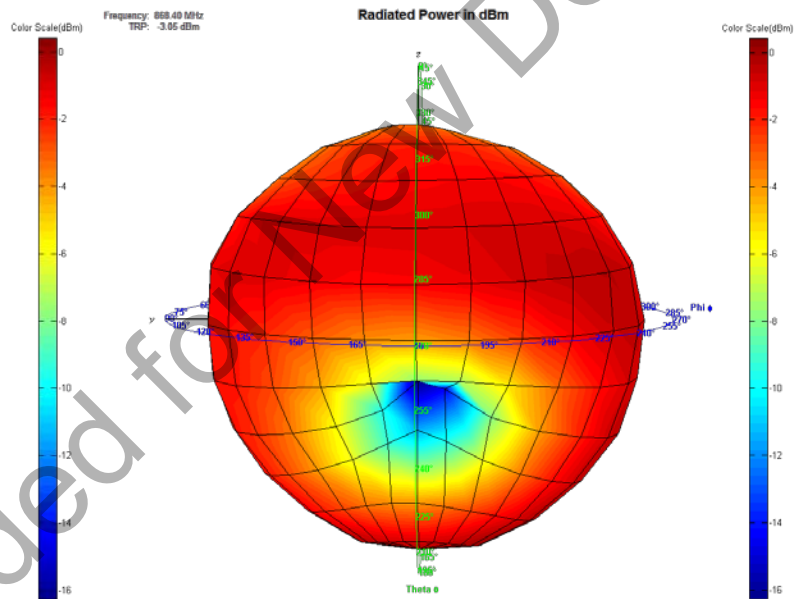

Figure 5.4: YZ plane (X back view)

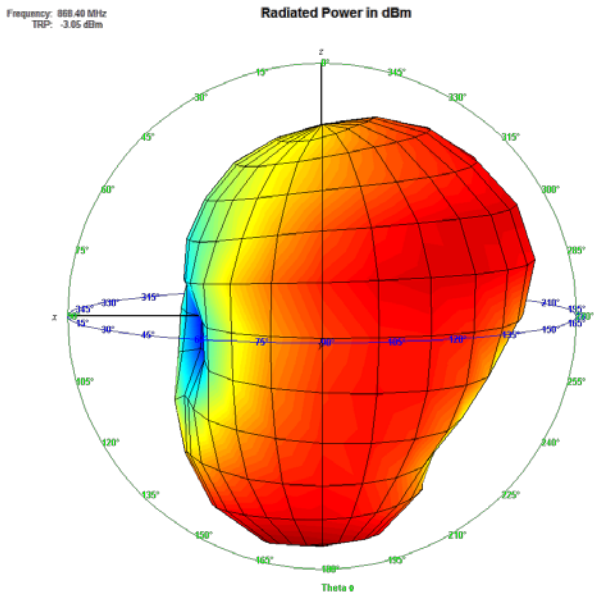

Figure 5.5: XZ plane (Y front view)

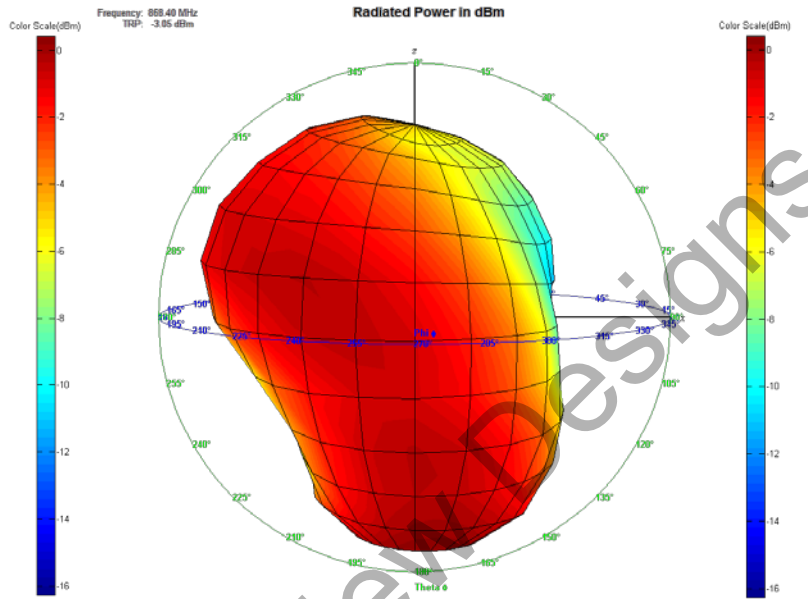

Figure 5.6: XZ plane (Y back view)

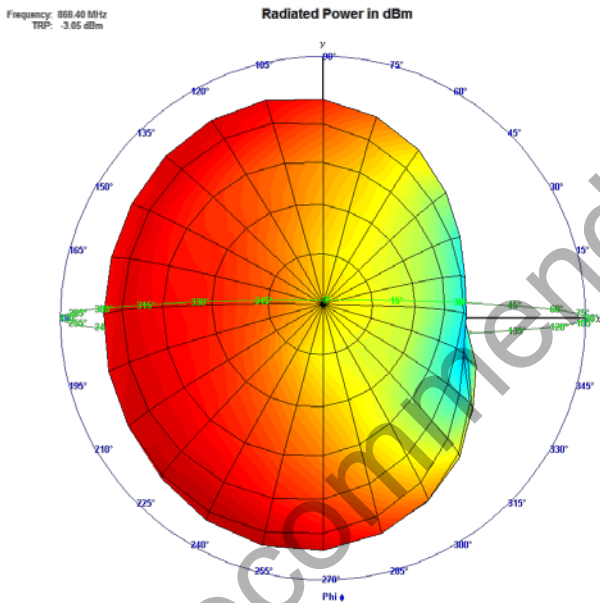

Figure 5.7: XY plane, (Z front view)

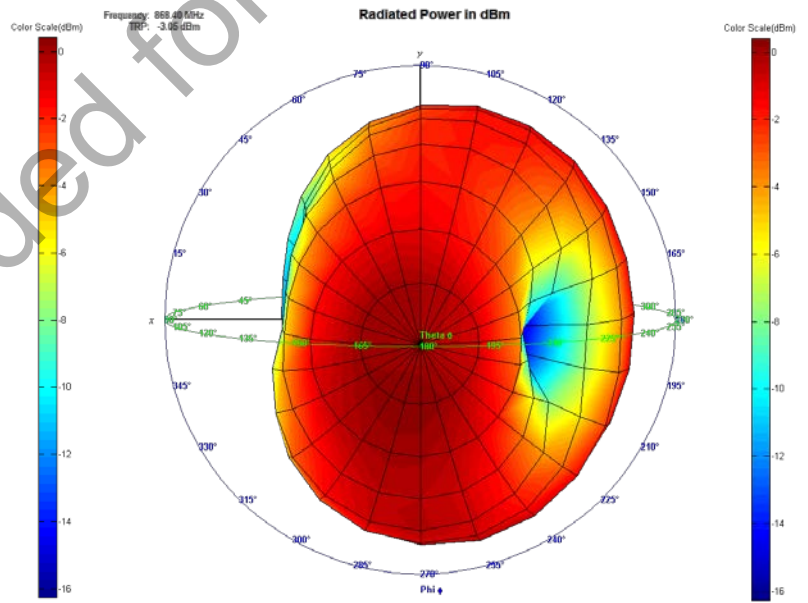

Figure 5.8: XY plane, (Z back view)

5.9.2.2 REGION U

Table 5.21: Region U performance

Symbol	Description	Min	Typ	Max	Unit
f_c	Carrier frequency	-	908.40	-	MHz
TRP	Total radiated power	-	-3.95	-	dBm
ε_R	Radiation efficiency	-	-7.95	-	dB
D	Directivity	-	4.21	-	dBi
G	Peak gain	-	-3.74	-	dBi

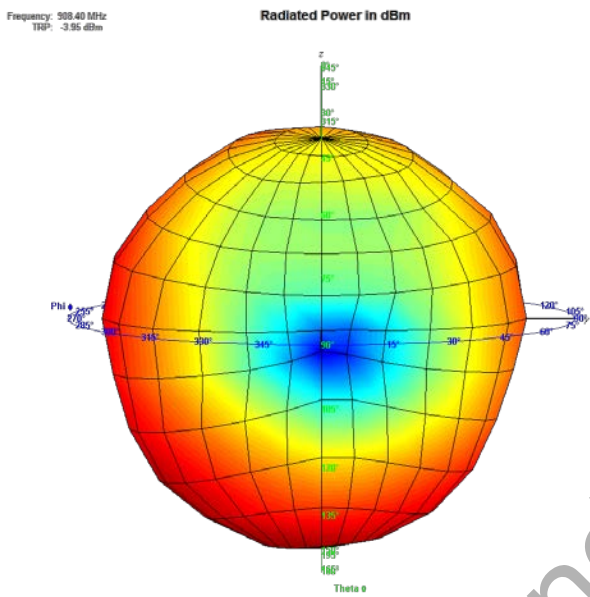

Figure 5.9: YZ plane (X front view)

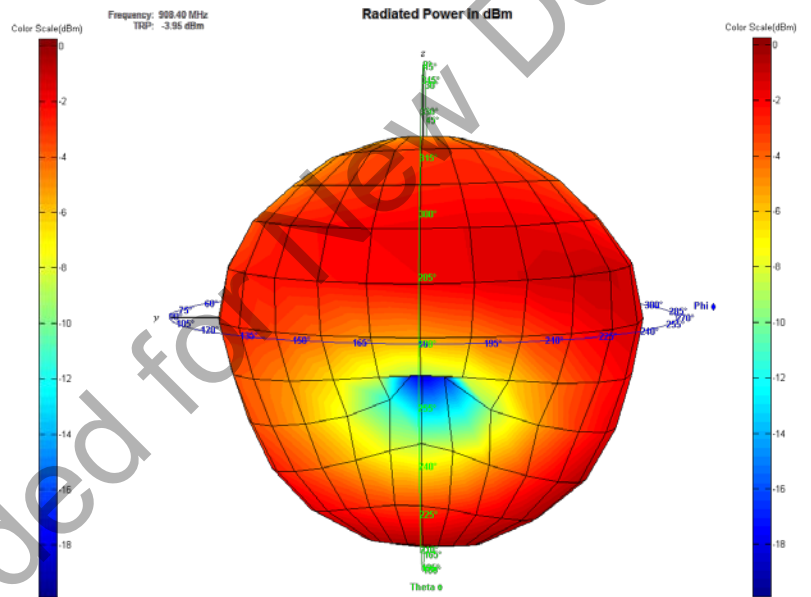

Figure 5.10: YZ plane (X back view)

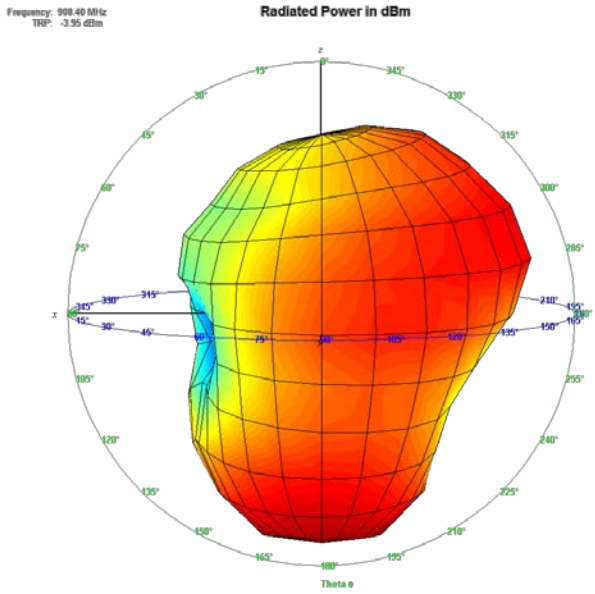

Figure 5.11: XZ plane (Y front view)

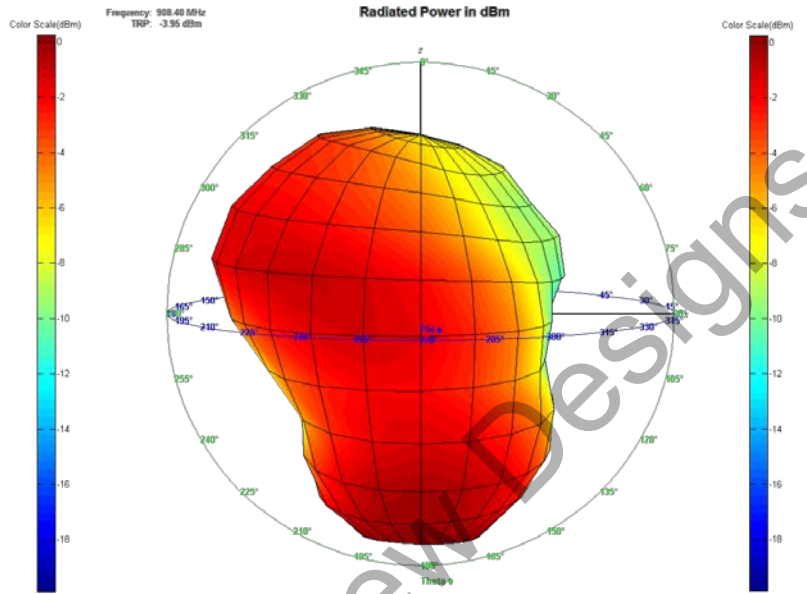

Figure 5.12: XZ plane (Y back view)

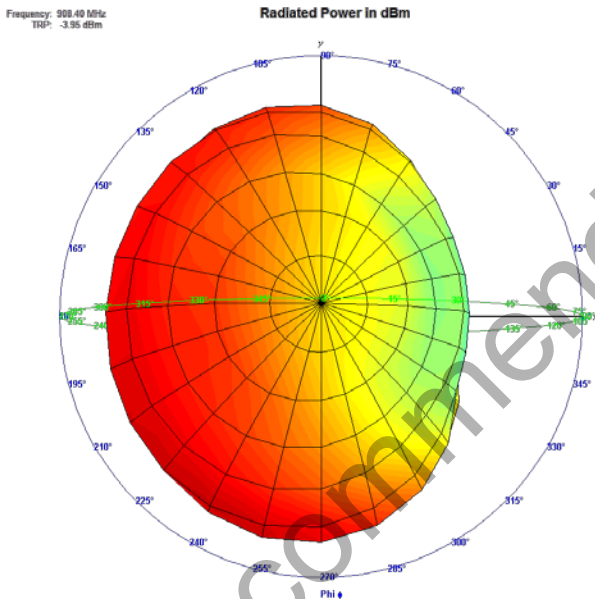

Figure 5.13: XY plane (Z front view)

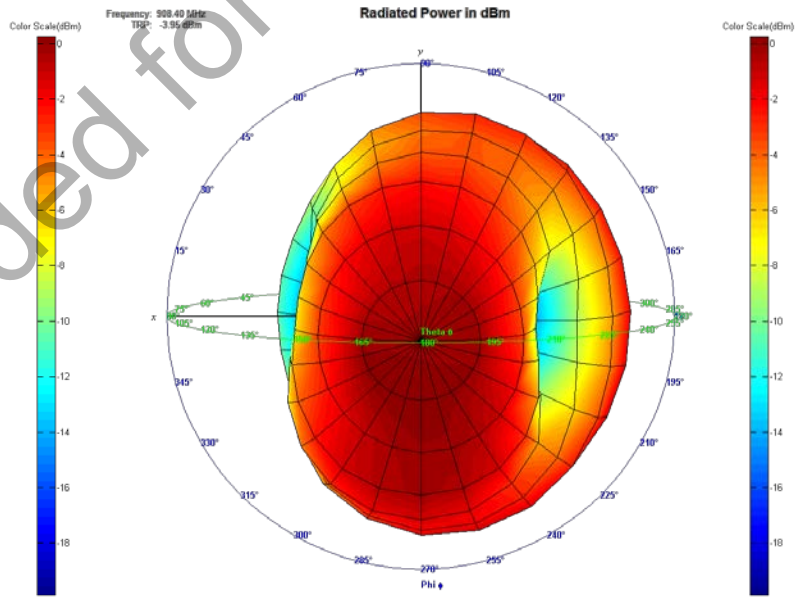

Figure 5.14: XY plane (Z back view)

5.9.2.3 REGION H

Table 5.22: Region H performance

Symbol	Description	Min	Typ	Max	Unit
f_c	Carrier frequency	-	921.40	-	MHz
TRP	Total radiated power	-	-7.73	-	dBm
ε_R	Radiation efficiency	-	-11.73	-	dB
D	Directivity	-	4.26	-	dBi
G	Peak gain	-	-7.47	-	dBi

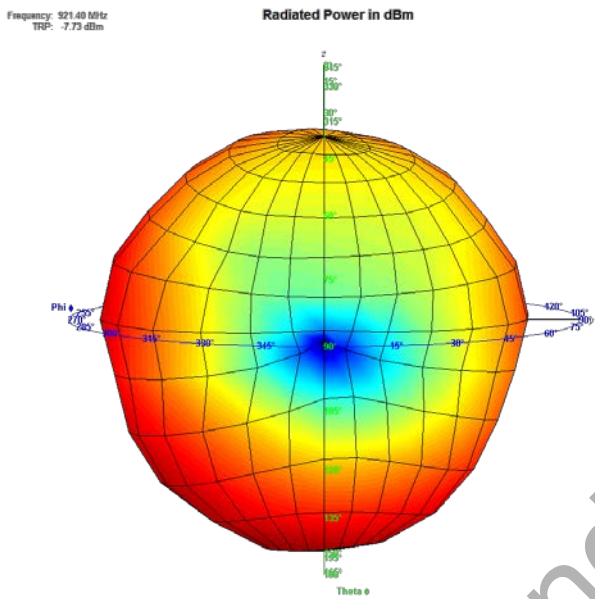

Figure 5.15: YZ plane (X front view)

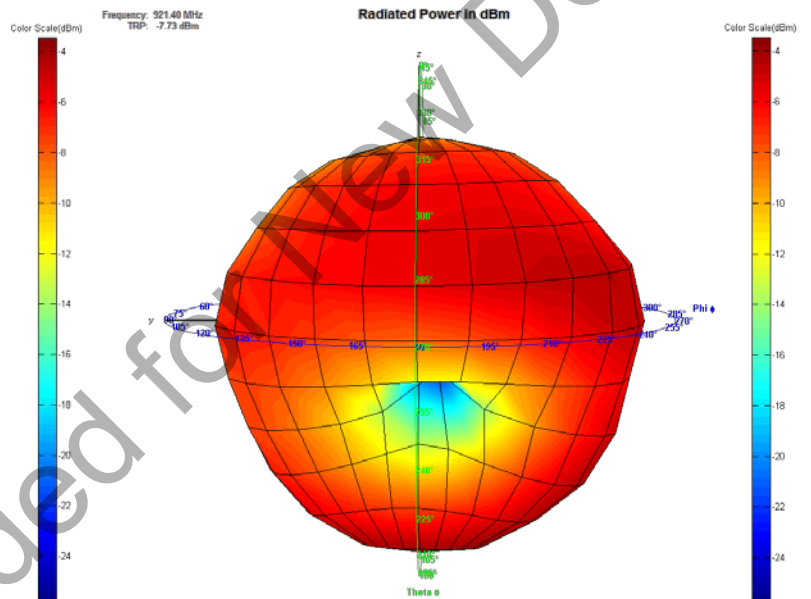

Figure 5.16: YZ plane (X back view)

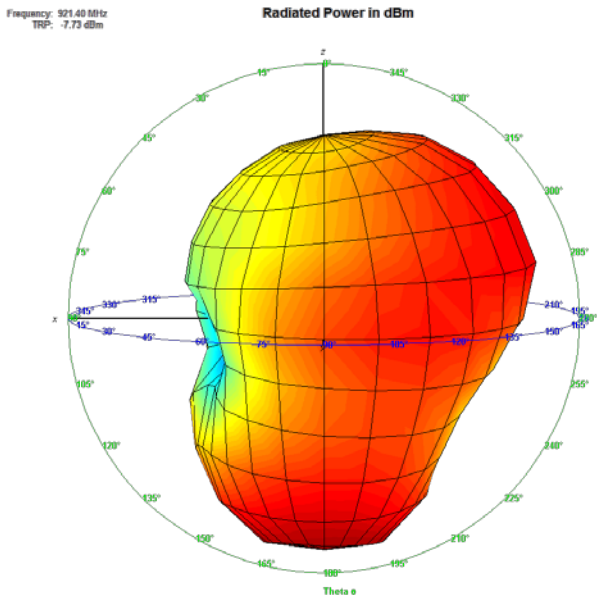

Figure 5.17: XZ plane (Y front view)

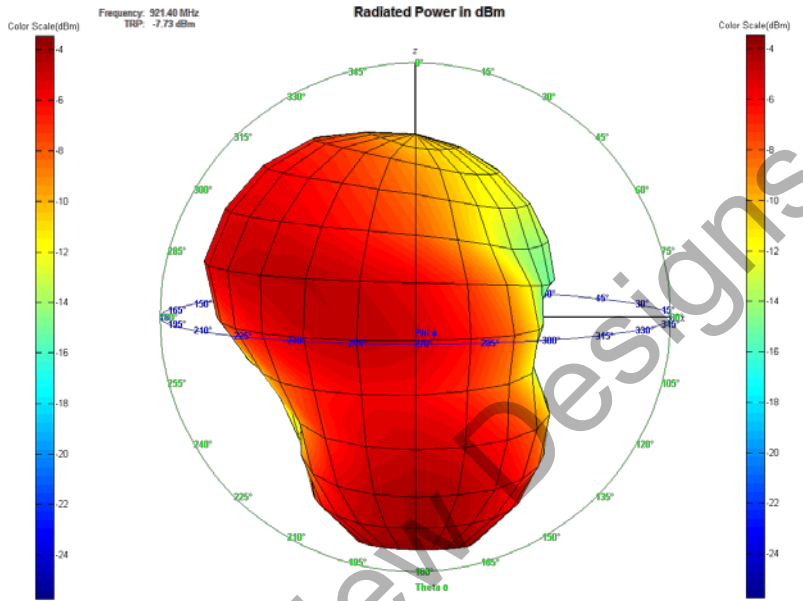

Figure 5.18: XZ plane (Y back view)

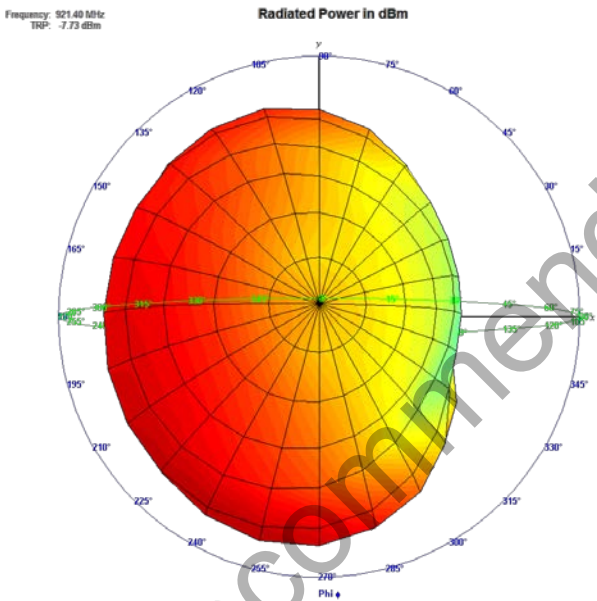

Figure 5.19: XY plane (Z front view)

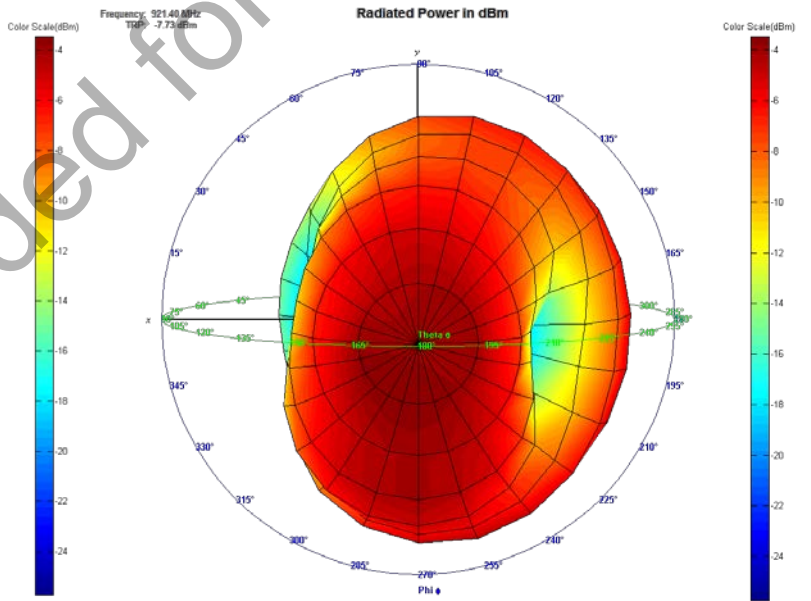



Figure 5.20: XY plane (Z back view)

5.9.3 REGULATORY COMPLIANCE

The ZM5304 has been tested on the ZDP03A Z-Wave Development Platform to be compliant with the following regulatory standards.

- **ACMA COMPLIANCE**
 - AS/NZS 4268
 - CISPR 22
- **CE COMPLIANCE**
 - EN 300 220-1/2
 - EN 301 489-1/3
 - EN 55022
 - EN 60950-1
 - EN 61000-4-2/3
 - EN 62479
- **FCC COMPLIANCE**
 - FCC CFR 47 Part 15 Subpart C §15.212
- **IC COMPLIANCE³**
 - RSS-GEN
 - RSS-210
 - ANSI C63.10
- **MIC COMPLIANCE**
 - ARIB STD-T108
 -  R 020-170040

³ This module complies with RSS-210 of the Industry Canada Rules. Operation is subject to the following two conditions: (1) This device may not cause harmful interference, and (2) this device must accept any interference received, including interference that may cause undesired operation. This device is intended only for OEM integrators under the following conditions:

- The antenna must be installed such that 20 cm is maintained between the antenna and users, and
- The transmitter module may not be co-located with any other transmitter or antenna.

As long as 2 conditions above are met, further transmitter test will not be required. However, the OEM integrator is still responsible for testing their end-product for any additional compliance requirements required with this module installed

6 Z-WAVE FREQUENCIES

Table 6.1: Z-Wave RF specification

Data rate	9.6kbps	40kbps	100kbps	
Modulation	Frequency Shift Keying (FSK)	FSK	Gaussian Frequency Shift Keying (GFSK)	
Frequency deviation	$f_c \pm 20\text{kHz}$	$f_c \pm 20\text{kHz}$	$f_c \pm 29.3\text{kHz}$	
Coding	Manchester encoded	Non-return to Zero (NRZ)	NRZ	
United Arab Emirates	868.42 MHz	868.40 MHz	869.85 MHz	E
Australia	921.42 MHz	921.40 MHz	919.80 MHz	H
Brazil	921.42 MHz	921.40 MHz	919.80 MHz	H
Canada	908.42 MHz	908.40 MHz	916.00 MHz	U
Chile	908.42 MHz	908.40 MHz	916.00 MHz	U
China	868.42 MHz	868.40 MHz	869.85 MHz	E
European Union	868.42 MHz	868.40 MHz	869.85 MHz	E
Hong Kong	919.82 MHz	919.80 MHz	919.80 MHz	H
Israel	916.02 MHz	916.00 MHz	-	U
India	865.20 MHz	865.20 MHz	865.20 MHz	E
Japan	-	-	922.50 MHz	H
	-	-	923.90 MHz	H
	-	-	926.30 MHz	H
Korea	-	-	920.90 MHz	H
	-	-	921.70 MHz	H
	-	-	923.10 MHz	H
Mexico	908.42 MHz	908.40 MHz	916.00 MHz	U
Malaysia	868.12 MHz	868.10 MHz	868.10 MHz	E
New Zealand	921.42 MHz	921.40 MHz	919.80 MHz	H
Russia	869.02 MHz	869.00 MHz	-	E
Singapore	868.42 MHz	868.40 MHz	869.85 MHz	E
Taiwan	-	-	922.50 MHz	H
	-	-	923.90 MHz	H
	-	-	926.30 MHz	H
United States	908.42 MHz	908.40 MHz	916.00 MHz	U
South Africa	868.42 MHz	868.40 MHz	869.85 MHz	E

7 MODULE INFORMATION

7.1 MODULE MARKING

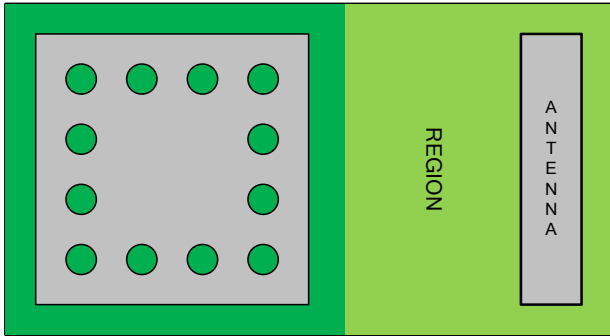

Figure 7.1: Marking placement

Table 7.1: Marking description

REGION	E
	Model: ZM5304-U
	FCC ID: D87-ZM5304-U
	IC: 11263A-ZM5304
	H

NB: The shield is only mounted on the U regional module.

7.2 MODULE DIMENSIONS

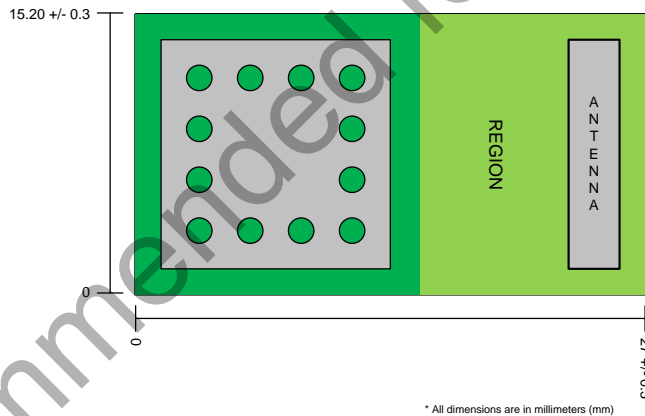

Figure 7.2: Top view of module

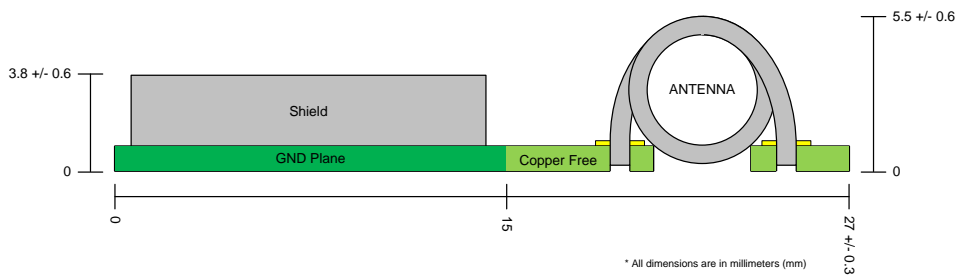

Figure 7.3: Side view of module

8 PROCESS SPECIFICATION

Specification	Description
MSL 3	Moisture Sensitivity Level designed and manufactured according to JEDEC J-STD-020C
REACH	REACH is a European Community Regulation on chemicals and their safe use (EC 1907/2006). It deals with the Registration, Evaluation, Authorisation and Restriction of Chemical substances
RoHS	Designed in compliance with The Restriction of Hazardous Substances Directive (RoHS)

9 PCB MOUNTING AND SOLDERING

9.1 PCB MOUNTING PATTERN

The land pattern is required to include two drilled holes of diameter 1.8mm at the positions indicated, to ensure clearance to antenna structures.

The recommended land pattern includes a layout of 48 pads of size 1.70 mm x 0.65 mm positioned as indicated in the figure.

All coordinates are relative to the centre of pad 11.

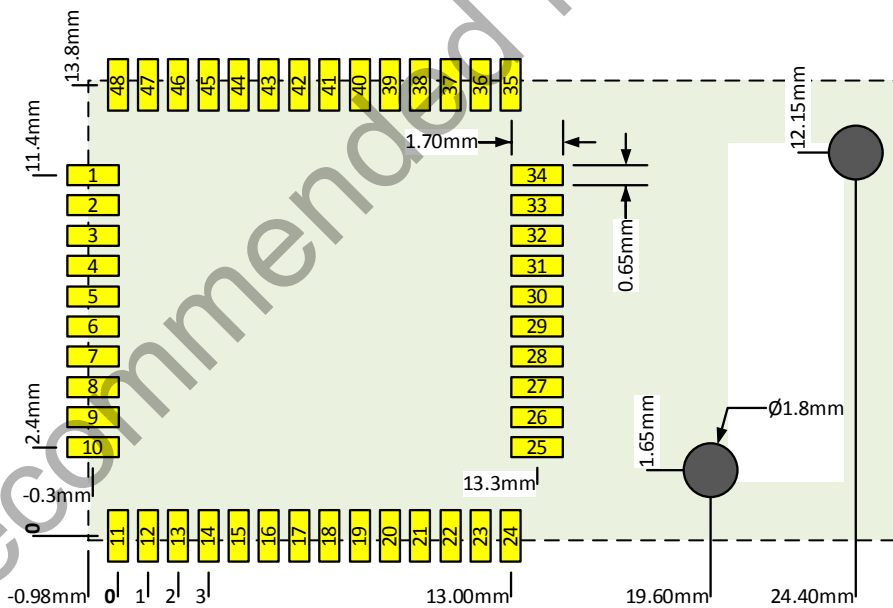

Figure 9.1: Top view of land pattern

9.2 RECOMMENDED PLACEMENT ON PCB

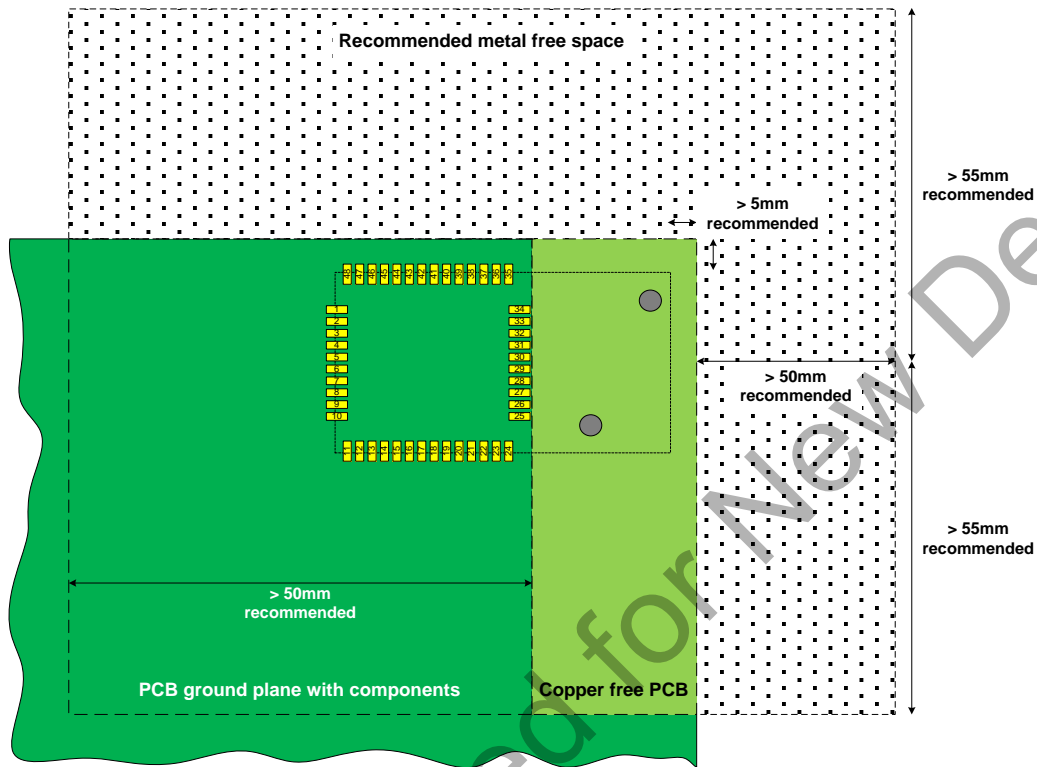

Figure 9.2: Top view of recommended placement of module on PCB

9.3 SOLDERING INFORMATION

The soldering details to properly solder the ZM5304 module on standard PCBs are described below. The information provided is intended only as a guideline and Silicon Labs is not liable if a selected profile does not work.

See IPC/JEDEC J-STD-020D.1 for more information.

Table 9.1: Soldering details

PCB solder mask expansion from landing pad edge	0.1 mm
PCB paste mask expansion from landing pad edge	0.0 mm
PCB process	Pb-free (Lead free for RoHS ⁴ compliance)
PCB finish	Defined by the manufacturing facility (EMS) or customer
Stencil aperture	Defined by the manufacturing facility (EMS) or customer
Stencil thickness	Defined by the manufacturing facility (EMS) or customer
Solder paste used	Defined by the manufacturing facility (EMS) or customer
Flux cleaning process	Defined by the manufacturing facility (EMS) or customer

⁴ RoHS = Restriction of Hazardous Substances Directive, EU

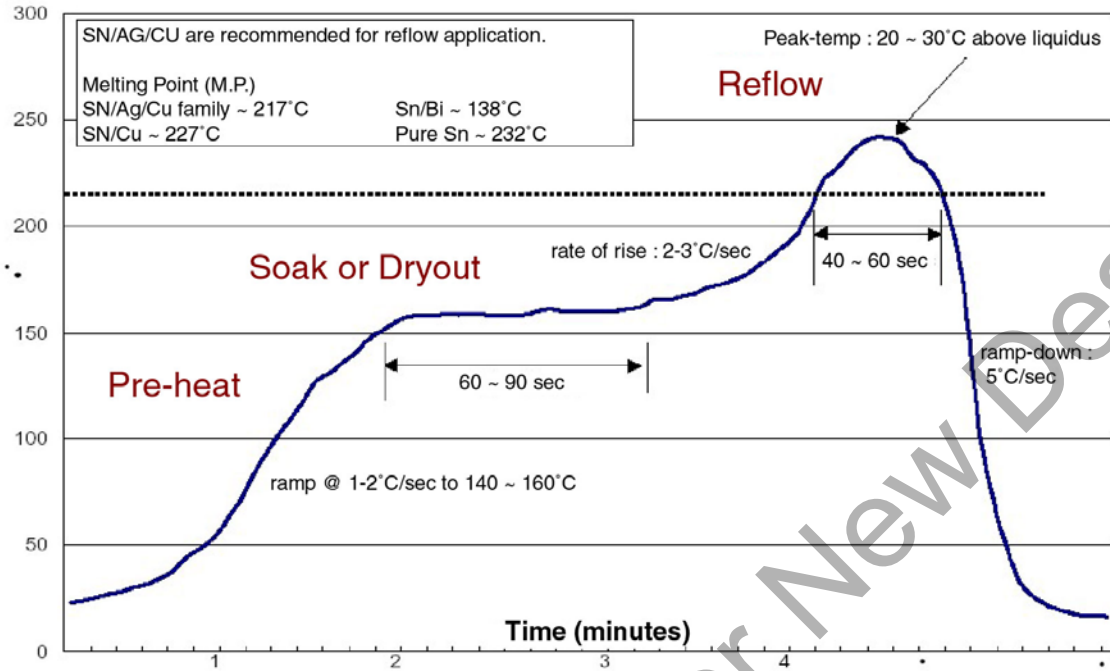

Figure 9.3: Typical reflow profile

9.4 VISUAL INFORMATION

The modules visual appearance can be different from the picture on the front page of this datasheet. I.e. colour of antenna and PCB is allowed to vary. Other visual elements like batch numbers and revisions may vary too. Functional and electrical performance will not be affected.

10 ORDERING INFORMATION

Table 10.1: Ordering codes

Orderable Device	Status	Package Type	Pins	Minimum Order Quantity	Description
ZM5304AE-CME3R	ACTIVE	SOM	48	500 pcs.	ZM5304 Modem Module, No Shield, RevA, 868MHz Band, Tape and Reel
ZM5304AU-CME3R	ACTIVE	SOM	48	500 pcs.	ZM5304 Modem Module, With Shield, RevA, 908MHz Band, Tape and Reel
ZM5304AH-CME3R	ACTIVE	SOM	48	500 pcs.	ZM5304 Modem Module, No Shield, RevA, 921MHz Band, Tape and Reel

Not Recommended for New Designs

10.1 TAPE AND REEL INFORMATION

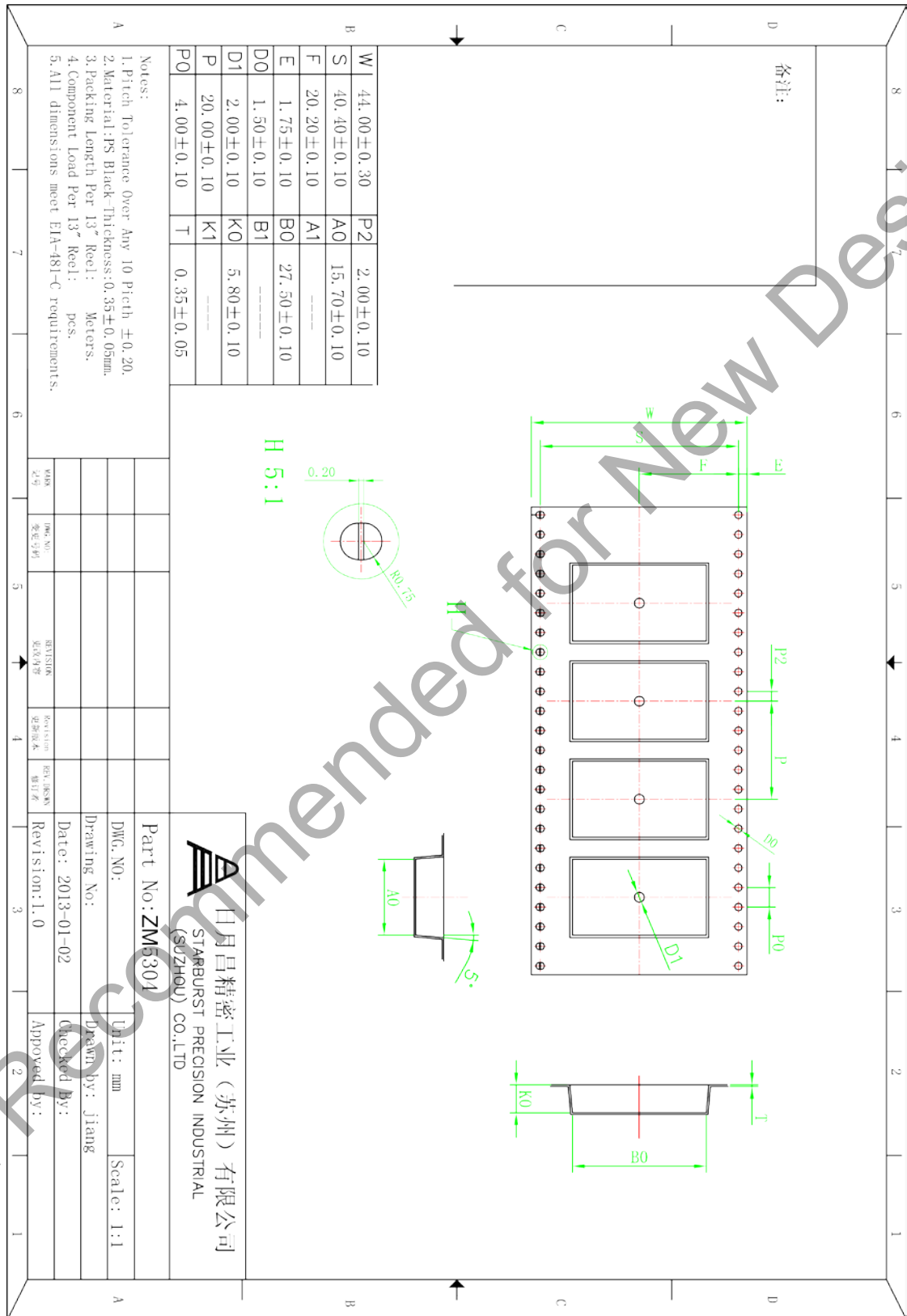

Figure 10.1: Tape information

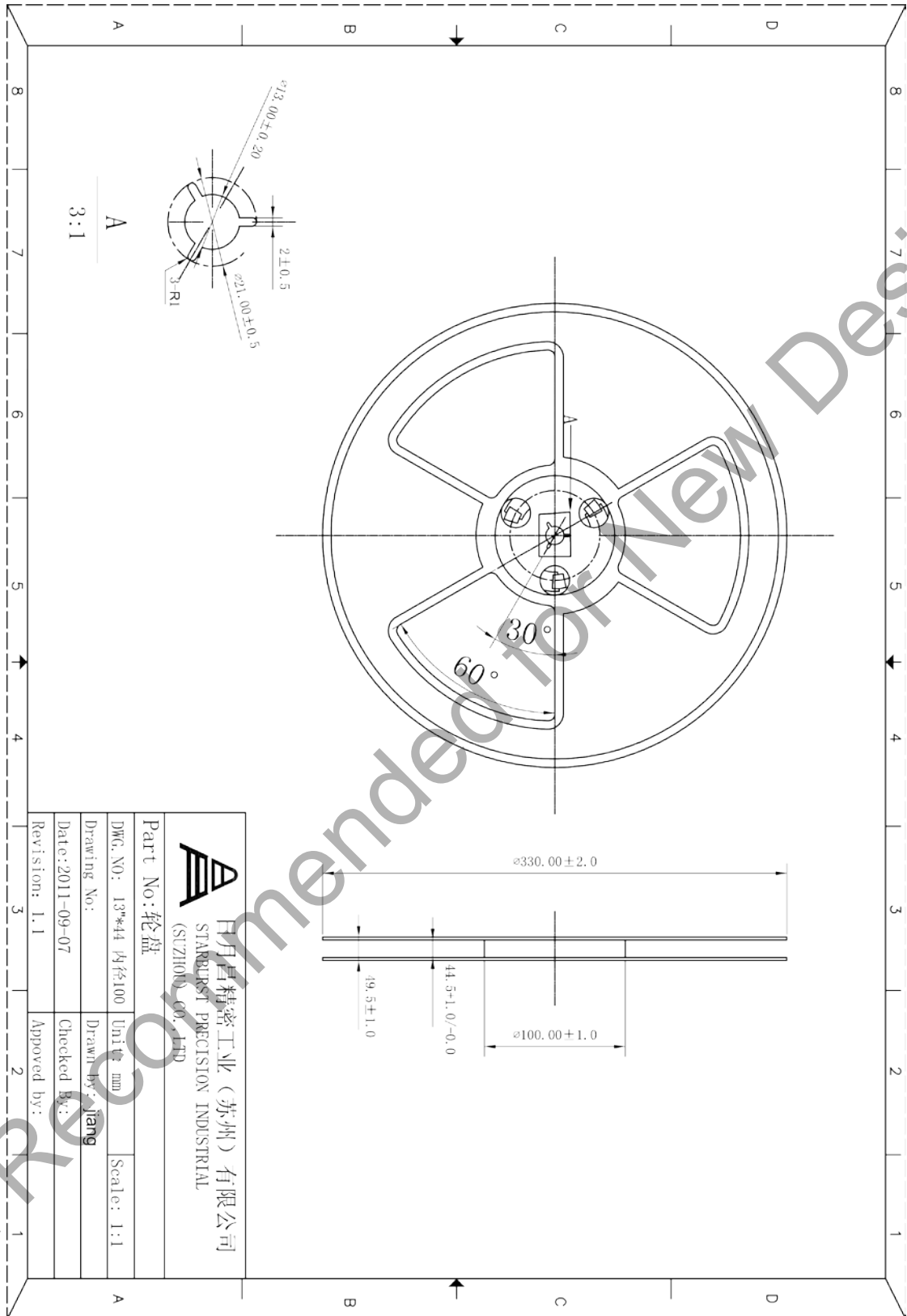
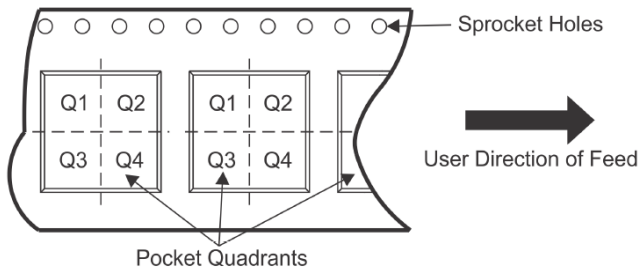

Figure 10.2: Reel information

QUADRANT ASSIGNMENTS FOR PIN 1 ORIENTATION IN TAPE



Parameter	Value
Pin 1 Quadrant	Pocket Quadrant Q1

10.2 CANADA IC STATEMENT

This device complies with RSS-210 of the Industry Canada Rules. Operation is subject to the following two conditions: (1) This device may not cause harmful interference, and (2) this device must accept any interference received, including interference that may cause undesired operation.

Ce dispositif est conforme à la norme CNR-210 d'Industrie Canada applicable aux appareils radio exempts de licence. Son fonctionnement est sujet aux deux conditions suivantes: (1) le dispositif ne doit pas produire de brouillage préjudiciable, et (2) ce dispositif doit accepter tout brouillage reçu, y compris un brouillage susceptible de provoquer un fonctionnement indésirable.

THIS DEVICE IS INTENDED ONLY FOR OEM INTEGRATORS UNDER THE FOLLOWING CONDITIONS: (FOR MODULE DEVICE USE)

- 1) The antenna must be installed such that 20 cm is maintained between the antenna and users, and
- 2) The transmitter module may not be co-located with any other transmitter or antenna.

As long as 2 conditions above are met, further transmitter test will not be required. However, the OEM integrator is still responsible for testing their end-product for any additional compliance requirements required with this module installed.

CET APPAREIL EST CONÇU UNIQUEMENT POUR LES INTÉGRATEURS OEM DANS LES CONDITIONS SUIVANTES: (POUR UTILISATION DE DISPOSITIF MODULE)

- 1) L'antenne doit être installée de telle sorte qu'une distance de 20 cm est respectée entre l'antenne et les utilisateurs, et
- 2) Le module émetteur peut ne pas être coïmplanté avec un autre émetteur ou antenne.

Tant que les 2 conditions ci-dessus sont remplies, des essais supplémentaires sur l'émetteur ne seront pas nécessaires. Toutefois, l'intégrateur OEM est toujours responsable des essais sur son produit final pour toutes exigences de conformité supplémentaires requis pour ce module installé.

IMPORTANT NOTE:

In the event that these conditions can not be met (for example certain laptop configurations or co-location with another transmitter), then the Canada authorization is no longer considered valid and the IC ID can not be used on the final product. In

these circumstances, the OEM integrator will be responsible for re-evaluating the end product (including the transmitter) and obtaining a separate Canada authorization.

NOTE

IMPORTANTE:

Dans le cas où ces conditions ne peuvent être satisfaites (par exemple pour certaines configurations d'ordinateur portable ou de certaines co-localisation avec un autre émetteur), l'autorisation du Canada n'est plus considéré comme valide et l'ID IC ne peut pas être utilisé sur le produit final. Dans ces circonstances, l'intégrateur OEM sera chargé de réévaluer le produit final (y compris l'émetteur) et l'obtention d'une autorisation distincte au Canada.

End Product Labeling

This transmitter module is authorized only for use in device where the antenna may be installed such that 20 cm may be maintained between the antenna and users. The final end product must be labeled in a visible area with the following: "Contains IC: ".

Plaque signalétique du produit final

Ce module émetteur est autorisé uniquement pour une utilisation dans un dispositif où l'antenne peut être installée de telle sorte qu'une distance de 20cm peut être maintenue entre l'antenne et les utilisateurs. Le produit final doit être étiqueté dans un endroit visible avec l'inscription suivante: "Contient des IC: ".

Manual Information To the End User

The OEM integrator has to be aware not to provide information to the end user regarding how to install or remove this RF module in the user's manual of the end product which integrates this module.

The end user manual shall include all required regulatory information/warning as show in this manual.

Manuel d'information à l'utilisateur final

L'intégrateur OEM doit être conscient de ne pas fournir des informations à l'utilisateur final quant à la façon d'installer ou de supprimer ce module RF dans le manuel de l'utilisateur du produit final qui intègre ce module. Le manuel de l'utilisateur final doit inclure toutes les informations réglementaires requises et avertissements comme indiqué dans ce manuel.

11 ABBREVIATIONS

Abbreviation	Description
2FSK	2-key Frequency Shift Keying
2GFSK	2-key Gaussian Frequency Shift Keying
ACM	Abstract Control Model
ACMA	Australian Communications and Media Authority
ADC	Analog-to-Digital Converter
AES	Advanced Encryption Standard
API	Application Programming Interface
APM	Auto Programming Mode
AV	Audio Video
BOD	Brown-Out Detector
CBC	Cipher-Block Chaining
CDC	Communications Device Class
CE	Conformité Européenne
COM	Communication
CPU	Central Processing Unit
CRC	Cyclic Redundancy Check
D	Differential
D-	Differential Minus
D+	Differential Plus
DC	Direct Current
DMA	Direct Memory Access
ECB	Electronic CodeBook
EMS	Electronic Manufacturing Services
FCC	Federal Communications Commission
FER	Frame Error Rate
FLIRS	Frequently Listening Routing Slave
FSK	Frequency Shift Keying
GFSK	Gaussian Frequency Shift Keying
GPIO	General Purpose Input Output
I	Input
I/O	Input / Output
IC	Integrated Circuit
IF	Intermediate Frequency
IPC	Interconnecting and Packaging Circuits
IRAM	Indirectly addressable Random Access Memory
ISM	Industrial, Scientific, and Medical
ISP	In-System Programming
ITU	International Telecommunications Union
JEDEC	Joint Electron Device Engineering Council
Lsb	Least Significant Bit
LSB	Least Significant Byte
MCU	Micro-Controller Unit
MIC	Ministry of Internal affairs and Communications, Japan
Msb	Most Significant Bit
MSB	Most Significant Byte
NRZ	Non-Return-to-Zero
NVM	Non-Volatile Memory
NVR	Non-Volatile Registers
O	Output
OEM	Original Equipment Manufacturer
OFB	Output FeedBack

Abbreviation	Description
Pb	Lead
PCB	Printed Circuit Board
POR	Power-On Reset
RAM	Random Access Memory
RF	Radio Frequency
RoHS	Restriction of Hazardous Substances
ROM	Read Only Memory
RS-232	Recommended Standard 232
RX	Receive
S	Supply
SAW	Surface Acoustic Wave
SFR	Special Function Register
SOM	System-in-Module
SRAM	Static Random Access Memory
TX	Transmit
UART	Universal Asynchronous Receiver Transmitter
USB	Universal Serial Bus
XRAM	External Random Access Memory
XTAL	Crystal

Not Recommended for New Designs

12 REVISION HISTORY

Date	Version	Affected	Revision		
2018/02/19	14	§6, Table 6.1	Updated Korea frequency		
2017/05/02	13	§5.9.3	Added Gitteki mark		
2016/12/21	12	Table 5.5	Cleaned up “TBD” values		
2016/04/29	11	Table 5.11	Removed “t _{PGM_FULL_USB} ”		
		§2.1.4	Updated wording in section 2.1.4 Crystal driver and system clock		
2015/11/25	10	Figure 9.1	Footprint updated to Landing Solder Pad Toe and Heel 0.4mm. All pads on footprint are now aligned to center of pads on module. Drill hole diameter only stated in mm.		
		Figure 9.3	Updated to align with SD3503 recommendation.		
		Table 9.2	Removed – information included in updated Figure 9.1		
		§8	Added section Process Specification		
2015/02/17	9	§10.1	Added orientation of component in tape		
		§Cover	Updated picture on cover		
		§8.4	Added section “VISUAL INFORMATION”		
		§7.2	Added tolerances		
2014/12/19	9	§9.2	Adding full Canada IC statement		
2014/12/14	9	§Cover, §7.1	Updated with Canada IC number		
2014/04/11	7	§2.3.1	Mandatory mounting holes added to the PCB mounting pattern. Drawing and text is updated.		
2013/12/12	6A	§2.3.1	Increased RESET_N low period		
2013/11/13	5A	§Cover,	Updated with measurement values		
		§2.1.2,	Changed to a battery monitor implementation		
		Figure 2.4,	Added resistor values		
		Figure 2.5,	Removed size of application area		
		Figure 3.2,	Added UART0 and RESET_N as test points		
		§5.1,	Updated test conditions		
		§5.4,	Removed graph and updated current consumption values		
		Table 5.13,	Added NVM performance data		
		§5.9.1,	Replaced transmitter and receiver with a reference to SD3503		
		§5.9.2,	Added radiated measurements of the antennas		
		§5.9.3	Updated the standards list		
		2013/08/28	4B	§5.9, §12	Added transmitter and receiver bandwidth to Tables 5.19 and 5.21
		2013/08/26	4A	§Cover, §2, §3, §4, §5.2, §5.8, §6, §7, §11	Updated 4A revision description
Clarified cover page summary to reflect controller based applications					
Added FCC ID to cover page					
Changed TXD and RXD to UART0 TX and UART0 RX in Figure 2.1, Figure 3.1, and Figure 4.1					
Renamed ‘pad’ to ‘pin’ throughout document except §9.3					
Added pin dimensions to Figure 4.1					
Fixed Korea Z-Wave frequency					
Changed the location of the FCC ID label in Figure 7.1 and Figure 7.2					
2013/07/02	3A	§1, §2, §5	Updated Figure 7.3 to thru-hole antenna		
			Added table of abbreviations		
2013/07/02	2B	§2.1.8, §11	Removed remnants of WUT		
2013/07/01	2A	§2.1, §2.3, §7.2, §6	Removed invalid references to the WUT and added the date to the references		
			Added dimensions of shield		

Date	Version	Affected	Revision
			Changed the low operating voltage from 2.5V to 2.3V Added AES, ADC, XTAL driver, BOD, RST controller, WUT, Watchdog, and RF transceiver sections to the peripheral descriptions Changed "Firmware Upgrade" to "Module Programming" and added default programming mode Changed the module width to 15.05mm Removed the frequency from the module marking and added region data to the frequency table Added transition time values Removed empty page
2013/06/03	1F	\$5.5	
2013/05/31	1E	\$All	Updated IO characteristics and added USB termination resistor values
2013/05/30	1D	\$All	Added missing receiver graphs and proposed changes
2013/05/27	1C	\$All	Updated layout with feedback from the technical writer, and data from the latest corner tests
2013/02/22	1A	\$All	Preliminary draft released
2013/02/18	1A	\$All	Initial draft

Not Recommended for New Designs

13 REFERENCES

- [1] INS12350, Instruction, "Serial API Host Application Programming Guide"
- [2] INS12308, Instruction, "Z-Wave 500 Series Application Programmers Guide"
- [3] INS11681, Instruction, "500 Series Z-Wave Single Chip Programming Mode"
- [4] DSH12468, Datasheet, "ZDB5304 Z-Wave Development Board"
- [5] DSH12469, Datasheet, "SD3503"
- [6] INS12213, Instruction, "500 Series Hardware Integration Guide"
- [7] DSH11243, Datasheet, "ZDP03A, Z-Wave Development Platform"

Not Recommended for New Designs

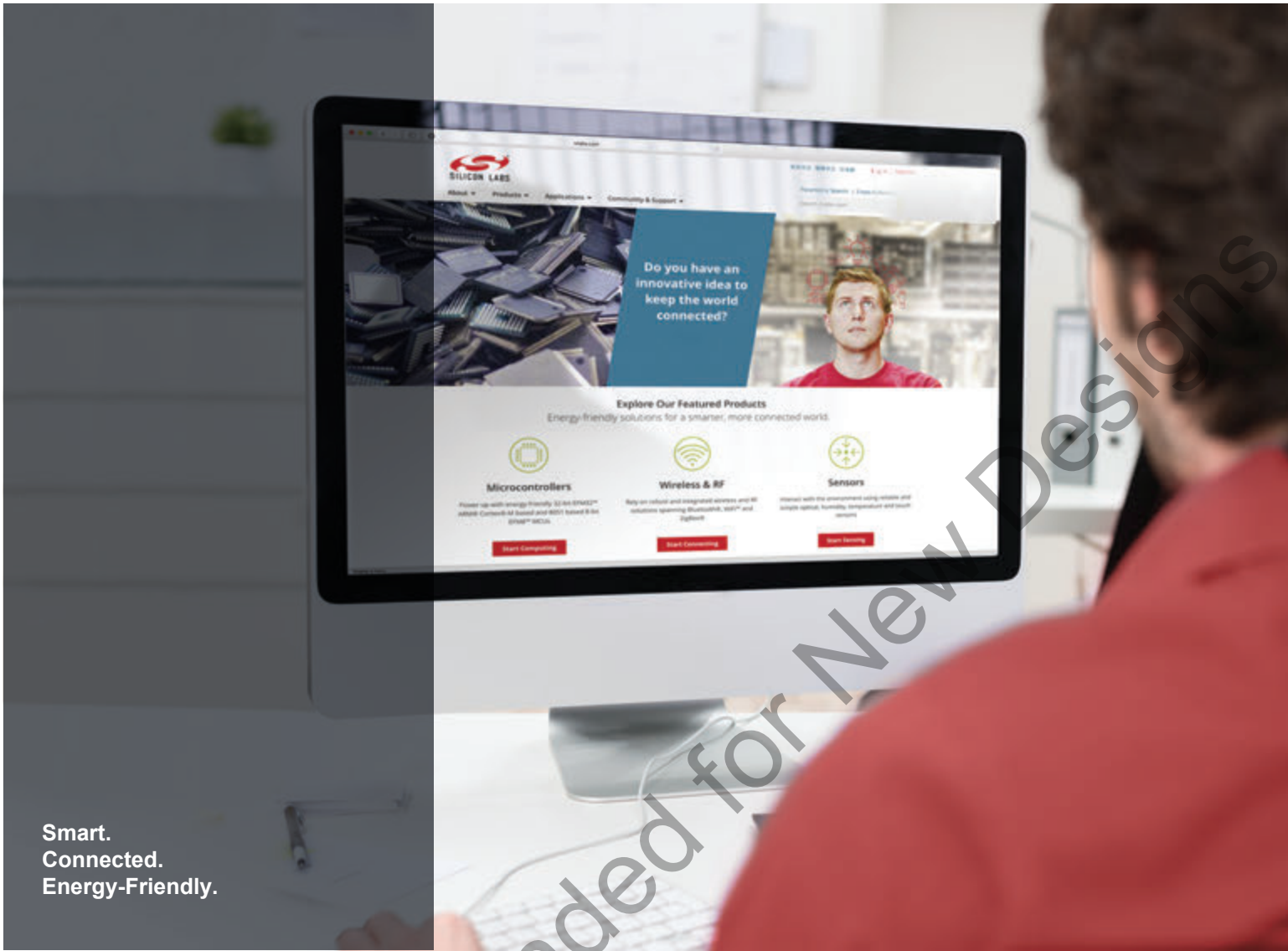

Smart.
Connected.
Energy-Friendly.



Products
www.silabs.com/products

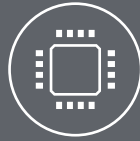

Quality
www.silabs.com/quality



Support and Community
community.silabs.com

Disclaimer

Silicon Labs intends to provide customers with the latest, accurate, and in-depth documentation of all peripherals and modules available for system and software implementers using or intending to use the Silicon Labs products. Characterization data, available modules and peripherals, memory sizes and memory addresses refer to each specific device, and "Typical" parameters provided can and do vary in different applications. Application examples described herein are for illustrative purposes only. Silicon Labs reserves the right to make changes without further notice and limitation to product information, specifications, and descriptions herein, and does not give warranties as to the accuracy or completeness of the included information. Silicon Labs shall have no liability for the consequences of use of the information supplied herein. This document does not imply or express copyright licenses granted hereunder to design or fabricate any integrated circuits. The products are not designed or authorized to be used within any Life Support System without the specific written consent of Silicon Labs. A "Life Support System" is any product or system intended to support or sustain life and/or health, which, if it fails, can be reasonably expected to result in significant personal injury or death. Silicon Labs products are not designed or authorized for military applications. Silicon Labs products shall under no circumstances be used in weapons of mass destruction including (but not limited to) nuclear, biological or chemical weapons, or missiles capable of delivering such weapons.

Trademark Information

Silicon Laboratories Inc.®, Silicon Laboratories®, Silicon Labs®, SiLabs® and the Silicon Labs logo®, Bluegiga®, Bluegiga Logo®, Clockbuilder®, CMEMS®, DSPLL®, EFM®, EFM32®, EFR®, Ember®, Energy Micro, Energy Micro logo and combinations thereof, "the world's most energy friendly microcontrollers", Ember®, EZLink®, EZRadio®, EZRadioPRO®, Gecko®, ISOmodem®, Micrium, Precision32®, ProSLIC®, Simplicity Studio®, SiPHY®, Telegesis, the Telegesis Logo®, USBXpress®, Zentri, Z-Wave and others are trademarks or registered trademarks of Silicon Labs. ARM, CORTEX, Cortex-M3 and THUMB are trademarks or registered trademarks of ARM Holdings. Keil is a registered trademark of ARM Limited. All other products or brand names mentioned herein are trademarks of their respective holders.



SILICON LABS

Silicon Laboratories Inc.
400 West Cesar Chavez
Austin, TX 78701
USA

<http://www.silabs.com>

Mouser Electronics

Authorized Distributor

Click to View Pricing, Inventory, Delivery & Lifecycle Information:

[Silicon Laboratories:](#)

[ZM5304AH-CME3R](#) [ZM5304AE-CME3R](#) [ZM5304AU-CME3R](#)