

SBS® Connectors - up to 110 amps



The patented SBS® connector family is designed to provide high power in a compact ergonomic housing with protection against accidental contact with live circuits. This is of particular importance in applications where DC voltages exceed 30 volts and can be health threatening.

Wire-to-wire and wire-to-board configurations both provide power contacts rated up to 110 amps. The SBS®75X offers up to 4 mate-last break-first auxiliary power / signal contacts rated up to 20 amps. The SBS®75G features a third first-mate last-break ground or power contact. All contact positions are rated for circuit interruption (hot plugging).

- **Touch Safe Interface**
 - Can safely be used in through panel applications
 - Minimizes potential contact with live circuits per IEC 60950
- **Wire-to-Wire and Wire-to-Board Configurations**
 - Allows one connector to meet multiple needs
- **Ground or Auxiliary Contacts Integrated into the One Piece Housing**
 - Meets all connection requirements in one compact connector housing

SBS® ORDERING INFORMATION |

SBS®50 Standard Housings

Polycarbonate housings feature 2 positions all finger proof. Genderless design mates with itself. Mechanical keys are color coded.

Description	Voltage		Part Numbers	
	Color	Code	-----	-----
Minimum Quantity	500	50	...
Red	24V	SBS50RED-BK	SBS50RED	
Gray	36V	SBS50GRA-BK	SBS50GRA	
Blue	48V	SBS50BLU-BK	SBS50BLU	
Green	72V	SBS50GRN-BK	SBS50GRN	
Black	80V	SBS50BLK-BK	SBS50BLK	
Brown	96V	SBS50BRN-BK	SBS50BRN	
White	192V	SBS50WHT-BK	SBS50WHT	

SBS®50 Chemical Resistant (CR) Housings

Same features as the standard housings, but molded out of a chemical resistant PBT/ PC blend. Suitable for use to -40°C.

Description	Voltage		Part Numbers	
	Color	Code	-----	-----
Minimum Quantity	500	50	...
Red	24V	PSBS50RED-BK	PSBS50RED	
Gray	36V	PSBS50GRA-BK	PSBS50GRA	
Blue	48V	PSBS50BLU-BK	PSBS50BLU	
Green	72V	PSBS50GRN-BK	PSBS50GRN	
Black	80V	PSBS50BLK-BK	PSBS50BLK	
Brown	96V	PSBS50BRN-BK	PSBS50BRN	

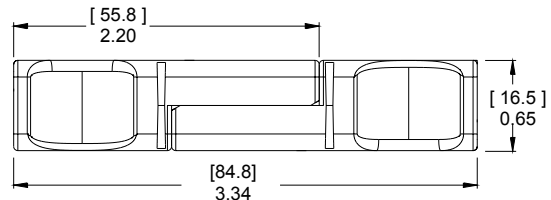
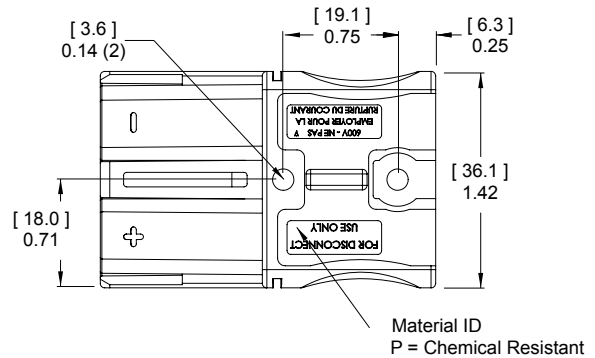

SBS®75X Standard Housings

Polycarbonate housings feature 4 auxiliary and 2 primary positions all finger proof. Genderless design mates with itself, or the PCB connector. Mechanical keys are color coded.

Voltage			
Color			
Description	Code	Part Numbers	
Minimum Quantity	250	50
Black	80V	SBS75XBLK-BK	SBS75XBLK
Brown	96V	SBS75XBRN-BK	SBS75XBRN

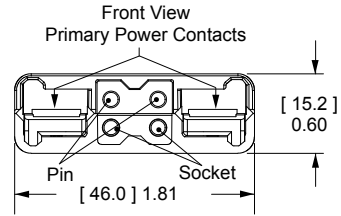

SBS®75X Chemical Resistant (CR) Housings

Same features as the standard housings, but molded out of a chemical resistant PBT/ PC blend. Suitable for use to -40°C.

Voltage			
Color			
Description	Code	Part Numbers	
Minimum Quantity	250	50
Green	72V	PSBS75XGRN-BK	PSBS75XGRN
Black	80V	PSBS75XBLK-BK	PSBS75XBLK

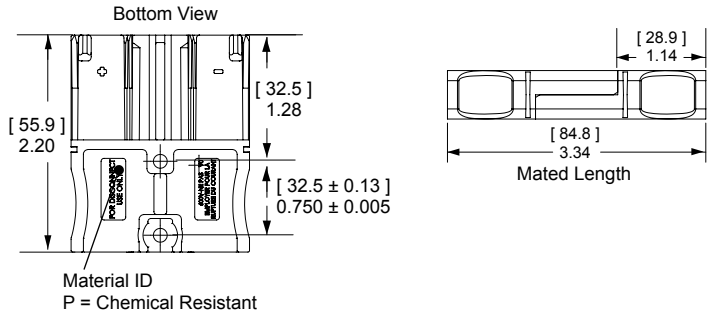

SBS®75X Assembled PCB Connector

Fully assembled PCB connector is designed to mate with SBS®75X Wire connector. All positions are preloaded with contacts including standard mating length auxiliary positions. Press fit board locks help secure the connector to the PCB before and after soldering.

Voltage			
Color			
Description	Code	Part Number	
Minimum Quantity	100
Black	80V	SBS75XPRBLK-BK	

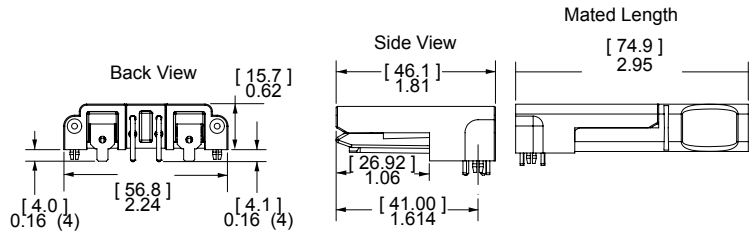

See PCB connector drawing on website for further detail.



SBS®75G Wire Housings

Polycarbonate housings feature three finger proof positions. The center position can be used for pre-mate power or ground. Genderless design mates with itself, or the PCB connector. Mechanical keys are color coded. Inquire with customer service for chemical resistant housings.

Voltage			
Color			
Description	Code	Part Numbers	
Minimum Quantity	250	50
Blue	48V	SBS75GBLU-BK	SBS75GBLU
Black	80V	SBS75GBLK-BK	SBS75GBLK
Brown	96V	SBS75GBRN-BK	SBS75GBRN
White	192V	SBS75GWHT-BK	SBS75GWHT

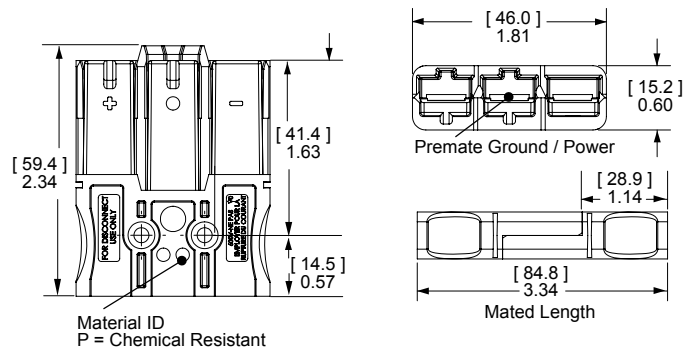

SBS®75G Assembled PCB Connector

Fully assembled PCB connector is designed to mate with SBS®75G Wire connector. Has press fit board locks to help secure the connector to the PCB before and after soldering.

Voltage			
Color			
Description	Code	Part Number	
Minimum Quantity	100
Black	80V	SBS75GPRBLK-BK	

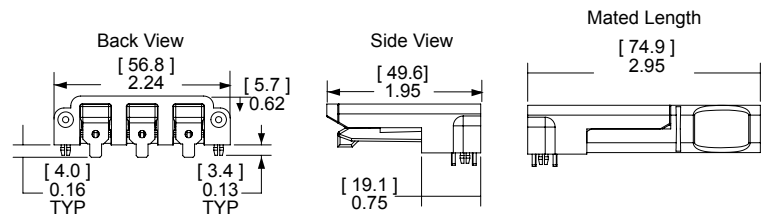

See PCB connector drawing on website for further detail.

SBS® Silver Plated Primary Power Wire Contacts

Use two silver plated contacts per housing for the best electrical performance and durability up to 10,000 mating cycles. Standard contacts are for use in all primary power positions for SBS® 50, 75X, & 75G wire housings. See reducing bushings in accessory section for smaller wires. See reducing busings in accessory section for smaller wires.

Type	AWG	mm ²	Loose Piece		Dimensions - A -	
			Part Numbers	Part Numbers	inches	mm
Minimum Quantity			1,000	100		
Standard	6	16	1339G2-BK	1339G2*	0.22	5.59
Standard	8	10	1339G5-BK	1339G5*	0.19	4.83
Standard	12 to 10	2.5 to 6	1339G3-BK	1339G3*	0.14	3.56

* Are sold as pairs. 2 contacts ship for every 1 ordered.

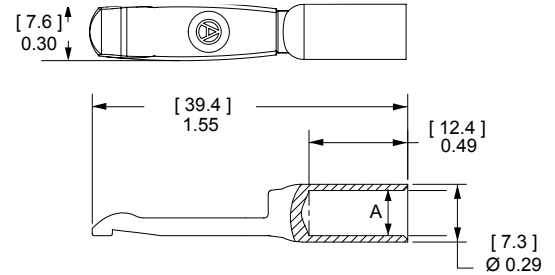

NEW SBS®75G Silver Plated Pre-Mate Wire Contacts

Pre-Mate contacts are for the center Pre-Mate position on the SBS®75G wire housings. See reducing bushings in accessory section for smaller wires.

Type	AWG	mm ²	Loose Piece		Dimensions - A -	
			Part Numbers	Part Numbers	inches	mm
Minimum Quantity			500	50		
Pre-Mate	6	16	1340G1-BK	1340G1	0.22	5.59
Pre-Mate	8	10	1340G2-BK	1340G2	0.19	4.83
Pre-Mate	12 to 10	2.5 to 6	1340G3-BK	1340G3	0.14	3.56

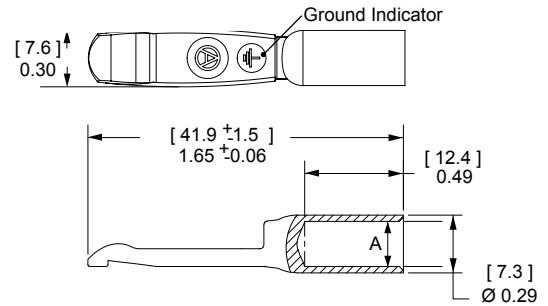

Pin Contacts for SBS®75x Auxiliary

Gold plated contacts are available in 3 lengths to allow sequencing of circuits.

Description	AWG	mm ²	Part Numbers	
			500	50
Minimum Quantity			500	50
Standard Length 7.7mm	12	2.5	PM16P12S30	PM16P12S30-50
	16 to 14	1.0 to 1.5	PM16P1416S30	PM16P1416S30-50
	20 to 16	0.75 to 1.0	PM16P1620S30	PM16P1620S30-50
	24 to 20	0.50 to 0.75	PM16P2024S30	PM16P2024S30-50
Pre-Mate 9.3mm	12	2.5	PM16P12A30	PM16P12A30-50
	16 to 14	1.0 to 1.5	PM16P1416A30	PM16P1416A30-50
	20 to 16	0.75 to 1.0	PM16P1620A30	PM16P1620A30-50
	24 to 20	0.50 to 0.75	PM16P2024A30	PM16P2024A30-50
Post-Mate 6.4mm	12	2.5	PM16P12C30	PM16P12C30-50
	16 to 14	1.0 to 1.5	PM16P1416C30	PM16P1416C30-50
	20 to 16	0.75 to 1.0	PM16P1620C30	PM16P1620C30-50
	24 to 20	0.50 to 0.75	PM16P2024C30	PM16P2024C30-50

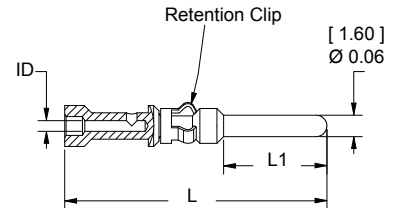

Auxiliary Pin Contact Lengths	- L -		- L1 -	
	in.	mm	in.	mm
Standard Length 7.7mm	0.77	19.6	0.30	7.7
Pre-Mate 9.3mm	0.83	21.2	0.37	9.3
Post-Mate 6.4mm	0.72	18.3	0.25	6.4

Socket Contacts for SBS®75x Auxiliary

Selectively gold plated contacts offer low resistance and durability up to 10,000 mating cycles.

Description	AWG	mm ²	Part Numbers	
			500	50
Minimum Quantity			500	50
Socket Contact	12	2.5	PM16S12S32	PM16S12S32-50
	16 to 14	1.0 to 1.5	PM16S1416S32	PM16S1416S32-50
	20 to 16	0.75 to 1.0	PM16S1620S32	PM16S1620S32-50
	24 to 20	0.50 to 0.75	PM16S2024S32	PM16S2024S32-50

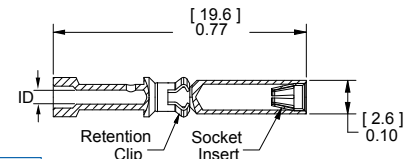

Auxiliary Socket Contacts Crimp Barrel ID

Wire Gauge	in.	mm.
#24 / 20	0.04	1.1
#20 / 16	0.07	1.7
#16 / 14	0.08	2.1
#12	0.10	2.6

SBS® CONNECTOR SPECIFICATIONS

Electrical

Current Rating Amperes ¹	UL 1977	CSA/TUV
Primary Power (6 AWG)	110	75
Auxiliary (12 AWG)	20	10
Voltage Rating AC/DC		
UL 1977	600	
Dielectric Withstanding Voltage		
Volts AC	2,200	
Avg. Mated Contact Resistance Milliohms¹		
Power & Ground: 1 1/4" of #6 AWG wire	0.200	
Auxiliary: Wire & PCB	3.000	
UL Hot Plug Current Rating Amperes - 250 cycles at 120V DC		
Wire & PCB Power	50A	
Wire & PCB Auxiliary	5A	
UL Ground Short Time Current Test - SBS75G Wire & PCB		
1530 Amps, #6 AWG Wire	6 seconds	

Materials

Housing	
Standard Plastic Resin	Polycarbonate
Chem. Resistant Resin	Polycarbonate / PBT blend
Contact Retention Spring	Stainless Steel
Housing Flammability Rating	
UL94	V-0
Wire Power & Ground Contact	Silver Plated Copper Alloy
PCB Power & Ground Contact	Tin Plated Copper Alloy
SBS75X Auxiliary Contacts	
Pin	Copper alloy, Au over Ni
Socket	BeCu, Au over Ni
Socket Body	Copper alloy, Sn bright over Ni
Retention Clip	Stainless Steel
PCB Press Fit Retainers	Brass - Tin Plated
Contact Termination Methods	
Crimp ³	Wire Contacts
Hand Solder	Wire and PCB Contacts
Solder Dip	PCB Contacts
Wave Solder	PCB Contacts

Auxiliary contacts are available for SBS®75X only.

SBS®75X and SBS®75G PCB connectors are designed to mate only with the wire connector of the same series.

¹ Based on: 105°C rated or better cable of the largest size, Properly calibrated APP® recommended tooling, and a 25°C ambient temperature. UL rating not to exceed the maximum operating temperature. CSA rating below a 30°C temperature rise.

² Limited by the thermal properties of the connector plastic housing.

³ Use APP® recommended tooling only. Alternate tools may adversely affect the performance of our connectors along with UL and CSA recognition.

Mechanical

Wire Size Range	AWG	mm ²	
Power Contacts (with bushings)	16 to 6	1.3 to 13.3	
Auxiliary Contacts	24 to 12	0.25 to 3.3	
Max. Wire Insulation Diameter			
	in.	mm	
SBS®75G Power & Ground	0.380	9.652	
SBS®50 & SBS®75X Power Contacts	0.410	10.414	
SBS®75X Auxiliary Contacts	0.140	3.600	
Operating Temperature²			
	°F	°C	
Standard	-4° to 221°	-20° to 105°	
Chemical Resistant	-40 to 221°	-40° to 105°	
Mating Cycles No Load by Plating			
	Silver (Ag)	Tin (Sn)	Gold (Au)
Power & Ground Contacts Wire	10,000		
Power & Ground Contacts PCB		1,500	
Auxiliary Contacts			10,000
Avg. Mating / Unmating Force			
	Lbf.	N	
SBS®75X and SBS®75G Wire to Wire	16	70	
SBS®50 Wire to Wire	8	36	
SBS®75X and SBS®75G Wire to PCB	8	36	
Min. Contact / Spring Retention Force			
	Lbf.	N	
Power, Standard Housing	50	222	
Power, Chem. Resistant Housing	30	133	
Aux. Standard Housing	15	67	
Aux. Chem. Resistant Housing	10	44	
PCB Specifications			
Mounting Style	Plated Through Hole		
Max PCB Thickness- in. [mm]	0.093 [2.4]		
Recommended Traces Power & Ground	#6 AWG Cross Section		
Recommended Traces Auxiliary	#12 AWG Cross Section		
Min. Creepage / Clearance Distance PCB			
	in.	mm	
Power to Aux. Creepage SBS®75X	0.41	10.4	
Power to Aux. Clearance SBS®75X	0.24	6.1	
Power to Ground Creepage SBS®75G	0.35	8.9	
Power to Ground Clearance SBS®75G	0.26	6.7	
Auxiliary Creepage SBS®75X	0.12	3.0	
Auxiliary Clearance SBS®75X	0.12	3.0	

Protection

Touch Safety with Wire Contacts & PCB Mating Interface

IEC 60950	Pass
IEC 60529	IP20



| SBS® CONNECTOR TEMPERATURE CHARTS |

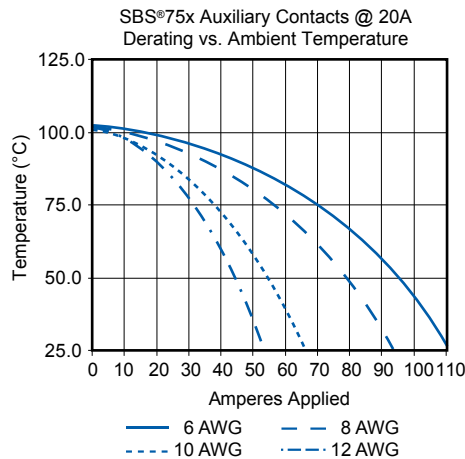
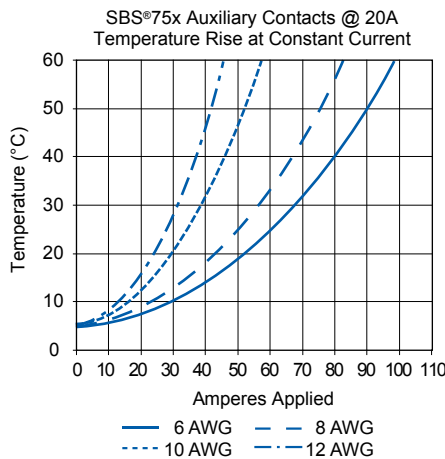
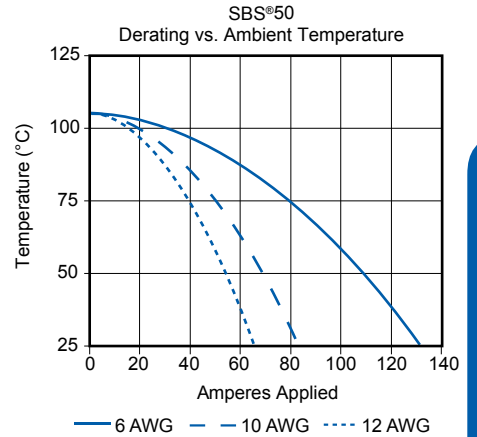
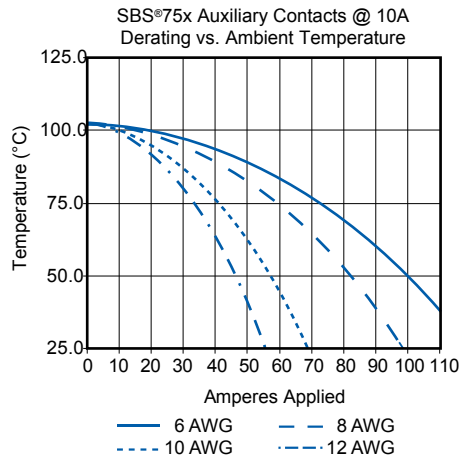
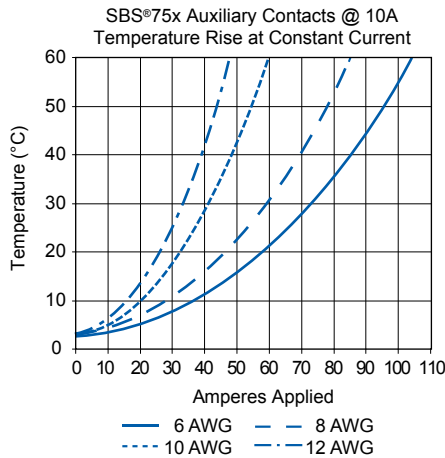
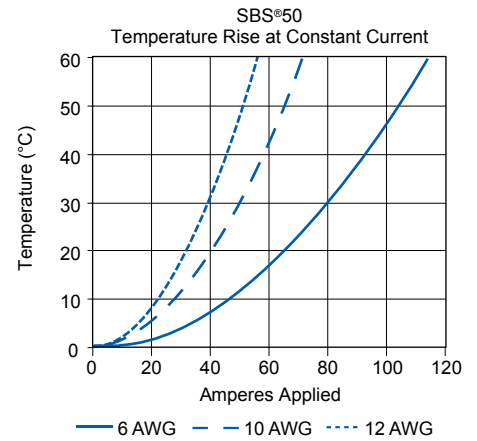
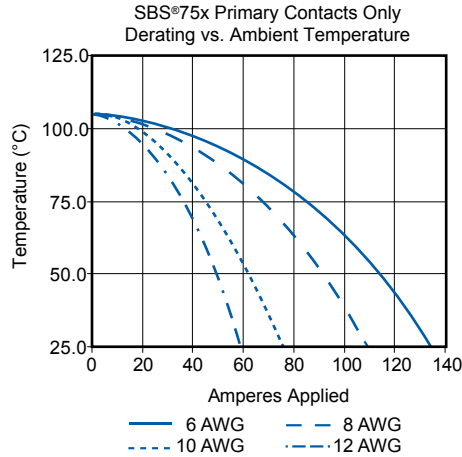
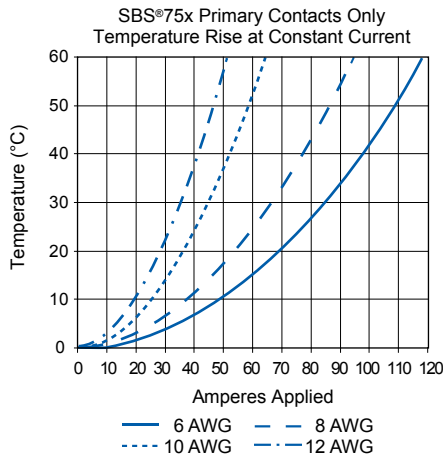

NOTE: Temperature rise charts are based on a 25°C ambient temperature.

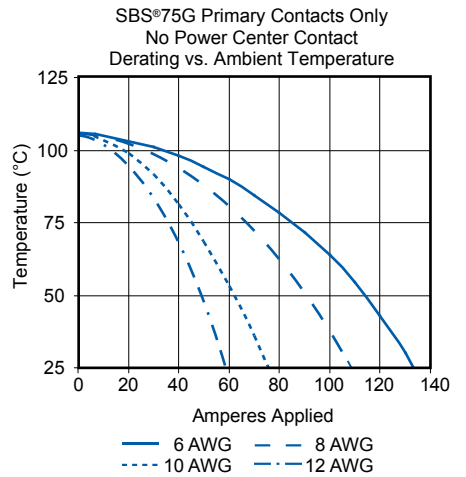
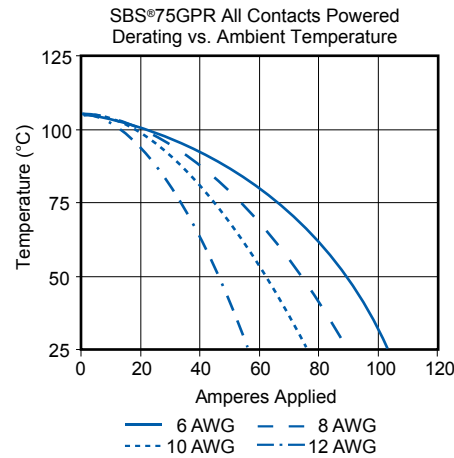
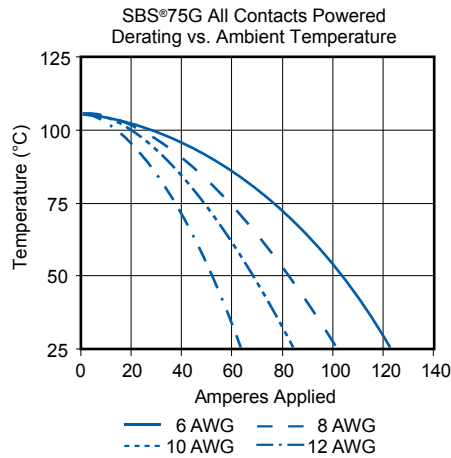
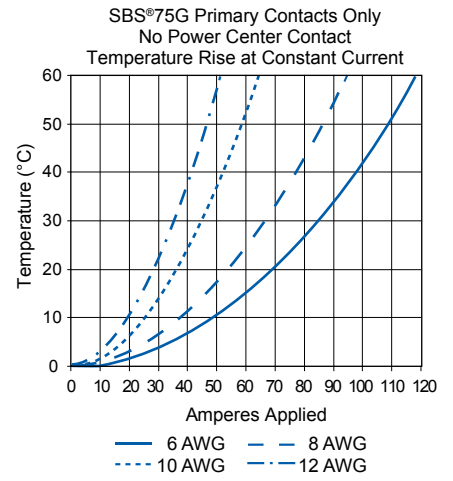
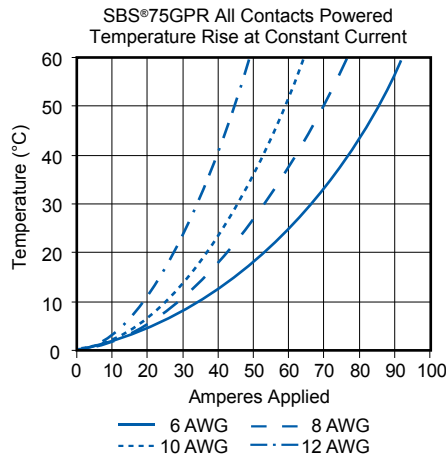
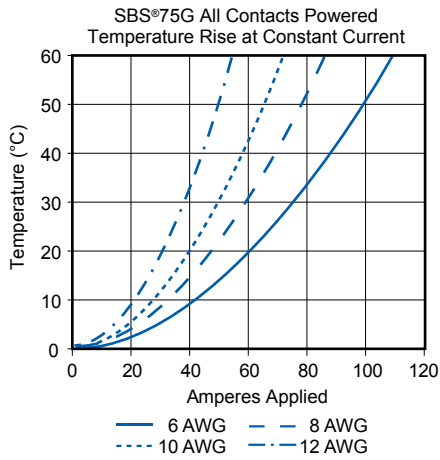

NOTE: Temperature rise charts are based on 25 °C ambient temperature.

SBS® Accessories

Mounting Clamp for SBS®50

Mounting clamps can be used for fastening a SBS®50 series housings to a panel. Fastening hardware not included.

Description	--- Part Number ---
Minimum Quantity	20 sets of 2
Panel Mount Bracket for SBS®50	1466G1

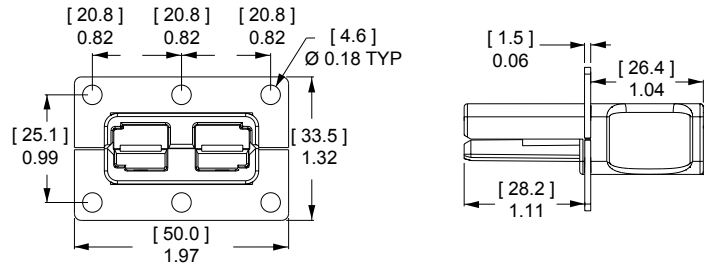

T-Handle for SBS®50 and SBS®75X

The "T" handle makes mating and unmating the connector easier. The non-conductive red plastic material is strong and safe. (2) Self tapping screws are used to secure the handle to the connector housing.

Description	----- Part Numbers -----	
Minimum Quantity	1,000	50
Red "T" Handle + Hardware Bag	-	SBS50-HDL-RED
Hardware Bag (2 Screws)	-	104G17
Red "T" Handle Only	113899P1	-
#8 x 5/8" Screw (Order 2 Per Handle)	H1120P53	-

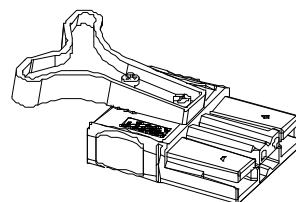

T-Handle for SBS®75G

The "T" handle makes mating and unmating the connector easier. The non-conductive red plastic material is strong and safe. (2) Machine screws and lock nuts.

Description	- Part Number -
Minimum Quantity	50
Red "T" Handle + Hardware Bag	SBS75GHDL

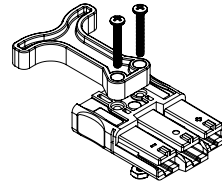

Dust Cover SBS®50

Prevents dust and dirt from entering the mating interface of the connector when unmated. NOTE: Not a Hermetic Seal.

Description	---- Part Number ----
Minimum Quantity	500 50
Dust Cover with Lanyard Strap, Red	113890P1 134G1

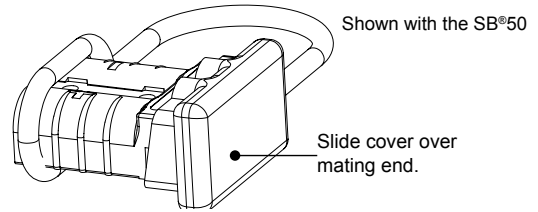

Cable Clamps for SBS®50

Durable metal cable clamps securely hold cables to prevent accidental strain or pulls from dislodging wire or contacts from the housing. Cable clamps are recommended for solder terminated wires.

Description	Cable Size		----- Part Numbers -----	
	AWG or (Inches O.D.)	mm ² or (mm O.D.)	500	50
Self Attaching for Discrete Conductor	8 to 6	10	990-BK	990
Self Attaching for Discrete Conductor	12 to 10	2.5 to 4	990G2-BK	990G2
Bolt On for Discrete Conductor	12 to 6	2.5 to 10	990G1-BK	990G1
Bolt On for Bundled Conductor	(0.320 to 0.450)	(4.27 to 11.43)	5905-BK	5905

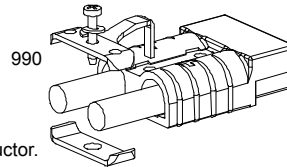
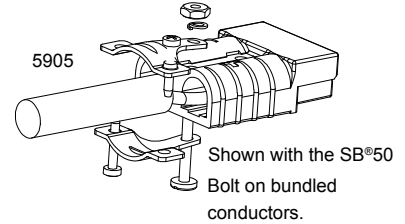

The given wire O.D. information is an estimate. Cable clamps should be evaluated for performance with the actual wire to be used.

Cable Clamps for SBS®75X with Integral Handle

Rugged chemical resistant PBT/ PC plastic cable clamps securely hold cables to prevent accidental strain or pulls from dislodging wire or contacts from the housing. Cable clamps are recommended for solder terminated wires.

Description	Cable Size AWG or (Inches O.D.)	mm ² or (mm O.D.)	----- Part Numbers -----	
			100	25
Large Wire Clamp Kit w/ Hardware	12 to 6 (0.39 to 0.60)	4 to 10 (9.9 to 15.2)	PSBS75XCLP1-BK	PSBS75XCLP1
Small Wire Clamp Kit w/ Hardware	12 to 6 (0.34 to 0.55)	4 to 10 (8.6 to 14.0)	PSBS75XCLP2-BK	PSBS75XCLP2

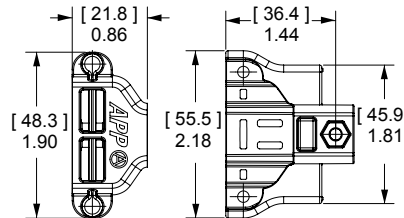

The given wire O.D. information is an estimate. Cable clamps should be evaluated for performance with the actual wire to be used.

Clamp hardware requires phillips or flat blade screwdriver to assemble.

Reducing Bushings

Use with contact part number 1339G2-BK or 1340G1-BK to allow a smaller wire to be used with the connector. Electrical capability is derated with smaller wire.

Contact Barrel Size	Wire Size	----- Part Numbers -----			Dimensions			
					- ID - inches mm	- Length - inches mm		
Minimum Quantity		3,000	1,000	100				
#6 AWG [13.3 mm ²]	#8 AWG [8.4 mm ²]	-	5912-BK	5912	0.18	4.57	0.45	11.43
#6 AWG [13.3 mm ²]	#12- 10 AWG [3.3- 5.3 mm ²]	5910-BK	-	5910	0.14	3.56	0.47	11.94
#6 AWG [13.3 mm ²]	#16- 14 AWG [1.3- 2.1 mm ²]	5913-BK	-	5913	0.09	2.29	0.47	11.94

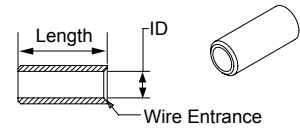

SBS® - Tooling Information

Wire Size		Power Contact Part Number	Pneumatic Bench Tool	+ Die	+ Locator	Number of Crimps	Hand Tool
AWG	mm ²						
#6	13.3	1339G2	1387G1	1388G6	1389G9	Single	1309G4
#8	8.4	1339G5		1388G7			
#10 / 12	5.3 / 3.3	1339G3		1388G6	1389G20		
#6	13.3	1340G1					
#8	8.4	1340G2					
#10 / 12	5.3 / 3.3	1340G3					

Wire Size		Auxiliary Contact Part Number	APP Hand Tool w/ Integral Locator	Mil Std. Hand Tool* M22520/1-01	Pneumatic Tool*	Number of Crimps	Locator for: TM0001 & TP0001
AWG	mm ²						
#12 / 24	2.5 / 0.25	All Crimp Pins	PM1000G1	O R TM0001	O R TP0001	Single	+ TL0001 TL0002
		All Crimp Sockets					

* TP0001 and TM0001 tools require locators TL0001 for Pins and TL0002 for Sockets.
NOTE: See website for the most current information.

Mouser Electronics

Authorized Distributor

Click to View Pricing, Inventory, Delivery & Lifecycle Information:

Anderson Power Products:

[1339G1-BK](#) [1339g2](#) [1339g2-bk](#) [1339G3](#) [1339G3-BK](#) [1339G4](#) [1339g5](#) [1339g5-bk](#) [1339g1](#) [PSBS50GRA](#)
[SBS50BLK](#) [SBS50BLK#10/12](#) [SBS50BLK#6](#) [sbs50blk-bk](#) [SBS50BLU](#) [SBS50BLU#10/12](#) [SBS50BLU#6](#) [SBS50BLU-](#)
[BK](#) [SBS50BRN](#) [SBS50BRN#10/12](#) [SBS50BRN#6](#) [SBS50BRN-BK](#) [SBS50GRA](#) [SBS50GRA#10/12](#) [SBS50GRA#6](#)
[SBS50GRA-BK](#) [SBS50-HDL-RED](#) [SBS50RED](#) [SBS50RED#10/12](#) [sbs50red#6](#) [SBS50RED-BK](#) [SBS50WHT](#)
[SBS50WHT#10/12](#) [SBS50WHT#6](#) [SBS50WHT-BK](#) [SBS75XBLK](#) [SBS75XBLK-BK](#) [SBS75XPRBLK](#) [SBS75XPRBLK-](#)
[BK](#) [PM16P12A30](#) [PM16P12B30](#) [PM16P12C30](#) [PM16P12S30](#) [PM16P1416A30](#) [PM16P1416B30](#) [PM16P1416S30](#)
[PM16P1620A30](#) [PM16P1620B30](#) [PM16P1620C30](#) [PM16P1620S30](#) [PM16P2024A30](#) [PM16P2024B30](#)
[PM16P2024S30](#) [PM16S12S30](#) [PM16S12S31](#) [PM16S12S32](#) [PM16S1416S32](#) [PM16S1620S32](#) [PM16S2024S30](#)
[PM16S2024S32](#) [SBS75xCLP2](#) [PSBS75XCLP2](#) [PSBS75XCLP1-BK](#) [PSBS75XCLP2-BK](#) [PM16P1416C30](#)
[PM16P2024C30](#) [PM16P12A30-50](#) [PM16P12B30-50](#) [PM16P12C30-50](#) [PM16P12S30-50](#) [PM16P1416A30-50](#)
[PM16P1416B30-50](#) [PM16P1416C30-50](#) [PM16P1416S30-50](#) [PM16P1620A30-50](#) [PM16P1620B30-50](#)
[PM16P1620C30-50](#) [PM16P1620S30-50](#) [PM16P2024A30-50](#) [PM16P2024B30-50](#) [PM16P2024C30-50](#)
[PM16P2024S30-50](#) [PM16S12S32-50](#) [PM16S1416S32-50](#) [PM16S1620S32-50](#) [PM16S2024S32-50](#) [PSBS75XBLK](#)
[SBS75XCLP1](#) [1340G3](#) [1340G1-BK](#) [SBS75GBLK-BK](#) [1340G3-BK](#) [SBS75GBLU-BK](#) [SBS75GBRN-BK](#) [1340G2](#)
[1340g1](#) [SBS75GWHT-BK](#) [SBS75XBRN-BK](#) [SBS75GPRBLK-BK](#) [SBS75GBLK](#)